

CHIAVI

PAG	286	CHIAVI COMBinate	
PAG	295	CHIAVI POLIGONALI DOPPIE DRITTE	
PAG	296	CHIAVI A FORCHETTA	
PAG	295	CHIAVI DOPPIE	
PAG	303	CHIAVI A RULLINO	
PAG	304	CHIAVI COMBinate A CRICCHETTO	
PAG	310	CHIAVI A CRICCHETTO	
PAG	313	ADATTATORI PER CHIAVI E CHIAVI MASCHIO PER CRICCHETTO	
PAG	314	CRICCHETTI	
PAG	318	CHIAVI PER RACCORDI TUBI	
PAG	322	CHIAVI A PERCUSSIONE	
PAG	327	CHIAVI A CRICCHETTO PER EDILIZIA	
PAG	329	CHIAVI DINAMOMETRICHE	
PAG	335	MOLTIPLICATORI DI COPPIA	
PAG	336	INDICATORI ANGOLARI DI COPPIA	

5 CHIAVI COMBINATE

CHIAVI COMBINATE



PRO+ CV POLIGONALE

CHIAVI COMBINATE CROMATE
CHROM-VANADIUM DIN 3113 TUV/GS
GERMANY

BGS articolo	mm	L mm	
BGS 30554	4	100	1
BGS 30553	4,5	100	1
BGS 30552	5	100	1
BGS 30555	5,5	100	1
BGS 1056	6	100	1
BGS 1057	7	110	1
BGS 1058	8	120	1
BGS 1059	9	130	1
BGS 1060	10	140	1
BGS 1061	11	150	1
BGS 1062	12	160	1
BGS 1063	13	170	1
BGS 1064	14	180	1
BGS 1065	15	190	1
BGS 1066	16	200	1
BGS 1067	17	210	1
BGS 1068	18	220	1
BGS 1069	19	230	1
BGS 1070	20	240	1
BGS 1071	21	250	1
BGS 1072	22	260	1
BGS 30573	23	270	1
BGS 1074	24	280	1
BGS 1075	25	290	1
BGS 1076	26	300	1
BGS 1077	27	310	1
BGS 1080	30	340	1
BGS 1082	32	365	1
BGS 1084	34	380	1
BGS 1086	36	400	1
BGS 1088	38	400	1
BGS 1091	41	440	1
BGS 1096	46	495	1
BGS 1100	50	530	1

CARATTERISTICHE

- chrom-vanadium
- cromate



POLIGONALE

OGNI MISURA
UN COLORE

SERIE 12 CHIAVI COMBINATE COLORATE:
8, 9, 10, 11, 12, 13, 14, 15, 16, 17, 18, 19 MM

articolo	Descrizione	
1398	SET 12 PEZZI	1



PRO+ CV POLIGONALE

BGS articolo	DESCRIZIONE
BGS 9290	SET 25 PEZZI, CHIAVI COMBINATE, FINITURA CROMATA, 6-32 MM

CARATTERISTICHE

- finitura cromata lucida
- misure: 6-7-8-9-10-11-12-13-14-15-16-17-18-19-20 21 22-23-24-25-26-27-28-30-32 mm
- In custodia
- peso 5,4 kg



PRO+ CV POLIGONALE

SET CHIAVI COMBINATE

BGS articolo	Nr. CHIAVI	MISURE
BGS 1194	12	6 - 22 MM
BGS 1190	25	6 - 32 MM

CARATTERISTICHE

- DIN 3113-A
- CHROM-VANADIUM
- finitura: cromata
- estremità dell'anello inclinata di 15°
- profilo estremità dell'anello: poligonale
- in scatola di cartone
- misure:
 - BGS 1194: 6 - 7 - 8 - 9 - 10 - 11 - 12 - 13 - 14 - 17 - 19 - 22 mm
 - BGS 1190: 6 - 7 - 8 - 9 - 10 - 11 - 12 - 13 - 14 - 15 - 16 - 17 - 18 - 19 - 20 - 21 - 22 - 23 - 24 - 25 - 26 - 27 - 28 - 30 - 32 mm

TOP



GERMANY

PRO+

CV

POLIGONALE

SET CHIAVI COMBinate

BGS articolo	Nr. CHIAVI	MISURE
BGS 1192	8	6 - 19 MM
BGS 1197	12	6 - 22 MM
BGS 1196	25	6 - 32 MM

CARATTERISTICHE

- DIN 3113-A
- **CHROM-VANADIUM**
- finitura: cromata
- estremità dell'anello inclinata di 15°
- profilo estremità dell'anello: poligonale
- **in custodia**
- misure:
 - BGS 1192: 6 - 8 - 10 - 11 - 13 - 14 - 17 - 19 mm
 - BGS 1197: 6 - 7 - 8 - 9 - 10 - 11 - 12 - 13 - 14 - 17 - 19 - 22 mm
 - BGS 1196: 6 - 7 - 8 - 9 - 10 - 11 - 12 - 13 - 14 - 15 - 16 - 17 - 18 - 19 - 20 - 21 - 22 - 23 - 24 - 25 - 26 - 27 - 28 - 30 - 32 mm

RICAMBI

BGS articolo	DESCRIZIONE
BGS 1196-LEER	CUSTODIA VUOTA PER BGS 1196

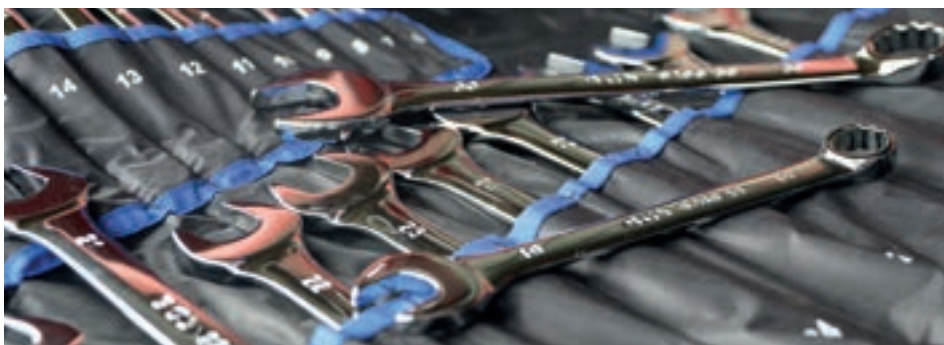

PRO+

CV

POLIGONALE

BGS articolo

DESCRIZIONE

BGS 1211

SET 12 PEZZI,
CHIAVI COMBinate,
6-22 MM

CARATTERISTICHE

- conforme DIN 3113
- finitura cromata, estremità lucide
- misure: 6-7-8-9-10-11-12-13-14-17-19-22 mm
- in supporto da parete in plastica
- peso 1,0 kg



BGS articolo

CV

POLIGONALE

BGS articolo

DESCRIZIONE

BGS 30035

SET 7 PEZZI,
CHIAVI COMBinate,
6-17 MM

CARATTERISTICHE

- conforme DIN 3113 A
- forgiate
- finitura cromata, estremità lucide
- misure: 6-8-10-11-13-14-17 mm
- in supporto in plastica
- peso 480 g

CHIAVI COMBinate

5 CHIAVI COMBinate

CHIAVI COMBinate

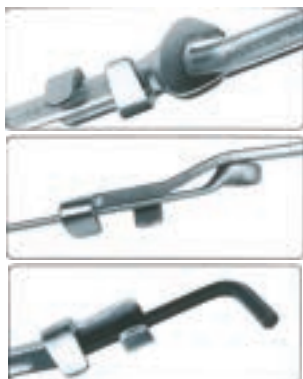
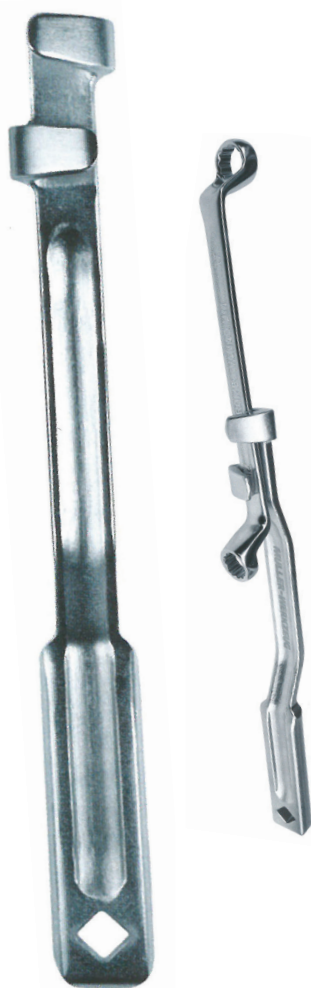

FERMEC
articolo
745 100

DESCRIZIONE

**LEVA DI PROLUNGA
PER CHIAVI**

CARATTERISTICHE

- lunghezza: 340 mm
- peso: 0,7 kg
- quadro di manovra: 1/2"
- per chiavi:



**CHIAVI COMBinate
CROMATE**

BGS articolo	mm	L mm	
BGS 1185-34	34	445	1
BGS 1185-36	36	450	1
BGS 1185-38	38	470	1
BGS 1185-41	41	500	1
BGS 1185-46	46	540	1
BGS 1185-50	50	600	1
BGS 1185-55	55	620	1
BGS 1185-57	57	630	1
BGS 1185-60	60	650	1
BGS 1185-65	65	670	1
BGS 1185-70	70	750	1
BGS 1185-75	75	720	1
BGS 1185-80	80	750	1
BGS 1185-85 NEW	85	850	1



BGS
articolo
BGS 1185

DESCRIZIONE

**SET 6 PEZZI, CHIAVI
COMBinate,
34-50 MM**

CARATTERISTICHE

- misure: 34-36-38-41-46-50 mm
- estremità lucide
- extra-lunghe
- in custodia
- peso 9,1 kg



**CHIAVI COMBinate CROMATE
CHROM-VANADIUM DIN 3113 TUV/GS
GERMANY
SERIE PESANTE**

FERMEC articolo	mm	L mm	
1033	33	461	1
1034	34	461	1
1036	36	490	1
1038	38	490	1
1041	41	540	1
1046	46	610	1
1050	50	610	1
1055	55	670	1
1060	60	760	1
1065	65	760	1

POLLICI



PRO+ **CV** **POLIGONALE**

**CHIAVI COMBINATE SATINATE
CHROM-VANADIUM DIN 3113 TUV/GS
GERMANY**

BGS articolo	pollici	L mm	
BGS 30188	1/4"	124	1
BGS 30189	5/16"	130	1
BGS 30190	3/8"	150	1
BGS 30191	7/16"	161	1
BGS 30192	1/2"	168	1
BGS 30193	9/16"	175	1
BGS 30194	5/8"	180	1
BGS 30673	19/32"	124	1
BGS 30195	11/16"	195	1
BGS 30196	3/4"	200	1
BGS 30675	25/32"	130	1
BGS 30197	13/16"	207	1
BGS 30198	7/8"	230	1
BGS 30199	15/16"	240	1
BGS 30680	1"	250	1
BGS 30681	1-1/32"	260	1
BGS 30683	1-1/8"	271	1
BGS 30685	1-1/4"	295	1

POLLICI



PRO+ **CV** **POLIGONALE**

BGS articolo	DESCRIZIONE
BGS 32100	SET 6 PEZZI, CHIAVI COMBINATE, IN POLLICI, 3/8" - 11/16"

CARATTERISTICHE

- misure: 3/8" - 7/16" - 1/2" - 9/16" - 5/8" - 11/16"
- finitura cromata, estremità lucide
- in supporto rigido

POLLICI



PRO+ **CV** **POLIGONALE**

BGS articolo	DESCRIZIONE
BGS 1195	SET 12 PEZZI, CHIAVI COMBINATE, IN POLLICI, 1/4" - 15/16"

CARATTERISTICHE

- misure: 1/4" - 5/16" - 3/8" - 7/16" - 1/2" - 9/16" - 5/8" - 11/16" - 3/4" - 13/16" - 7/8" - 15/16"
- finitura cromata
- DIN 3113
- chrom-vanadium
- in custodia
- peso 1,7 kg

RICAMBI

BGS articolo	DESCRIZIONE
BGS 1195-LEER NEW	CUSTODIA VUOTA PER BGS 1195

POLLICI **CROMATE LUCIDE**



CV **PRO+**

BGS articolo	DESCRIZIONE
BGS 9473	SET 25 PEZZI, CHIAVI COMBINATE IN POLLICI

CARATTERISTICHE

- forgiate a freddo
- in custodia
- finitura satinata cromata
- misura: 1/4" - 9/32" - 5/16" - 11/32" - 3/8" - 7/16" - 15/32" - 1/2" - 9/16" - 19/32" - 5/8" - 11/16" - 23/32" - 3/4" - 25/32" - 13/16" - 7/8" - 29/32" - 15/16" - 1" - 1 1/32" - 1 1/16" - 1 1/8" - 1 3/16" - 1 1/4"
- peso 5,4 kg

WHITWORTH



PRO+ **CV** **POLIGONALE**

BGS articolo	DESCRIZIONE
BGS 1199	SET 8 PEZZI, CHIAVI COMBINATE WHITWORTH, 1/8" WW - 9/16" WW

CARATTERISTICHE

- finitura lucida
- misure: 1/8" WW, 3/16" WW, 1/4" WW, 5/16" WW, 3/8" WW, 7/16" WW, 1/2" WW, 9/16" WW
- particolarmente indicate per auto d'epoca e trattori inglesi
- In custodia
- peso 1,3 kg



CHIAVI COMBinate CROMATE LUCIDE A RIPRESA RAPIDA EFFETTO CRICCHETTO DIN 3113

articolo	mm	
44220-8	8	1
44220-9	9	1
44220-10	10	1
44220-11	11	1
44220-12	12	1
44220-13	13	1
44220-14	14	1
44220-15	15	1
44220-16	16	1
44220-17	17	1
44220-18	18	1
44220-19	19	1



PRO+ CV

BGS articolo	DESCRIZIONE
BGS 8914	SET 13 PEZZI, CHIAVI COMBinate, CON EFFETTO CRICCHETTO, 8 - 21 MM

CARATTERISTICHE

- chiavi forgiate a freddo
- cromate satinata
- estremità aperta con speciale "effetto cricchetto"
- con anello poligonale sfasato 15°
- in custodia
- misure: 8 - 9 - 10 - 11 - 12 - 13 - 14 - 15 - 16 - 17 - 18 - 19 - 21 mm
- peso 1,4 kg



PRO+ CV POLIGONALE

CHIAVI COMBinate SATINATE CHROM-VANADIUM DIN 3113 TUV/GS GERMANY

BGS articolo	mm	L mm	
BGS 30506	6	95	1
BGS 30507	7	106	1
BGS 30508	8	117	1
BGS 30509	9	127	1
BGS 30510	10	138	1
BGS 30511	11	150	1
BGS 30512	12	159	1
BGS 30513	13	167	1
BGS 30514	14	177	1
BGS 30515	15	189	1
BGS 30516	16	198	1
BGS 30517	17	208	1
BGS 30518	18	220	1
BGS 30519	19	227	1
BGS 30520	20	235	1
BGS 30521	21	249	1
BGS 30522	22	259	1
BGS 30523	23	269	1
BGS 30524	24	278	1
BGS 30525	25	288	1
BGS 30526	26	296	1
BGS 30527	27	307	1
BGS 30528	28	316	1
BGS 30530	30	337	1
BGS 30532	32	358	1



PRO+ CV POLIGONALE

BGS articolo	DESCRIZIONE
BGS 1219	SET 19 PEZZI, CHIAVI COMBinate, 8-32 MM

CARATTERISTICHE

- finitura cromata satinata
- **forgiate a freddo**
- misure: 8-9-10-11-12-13-14-15-16-17-18-19-20-21-22-24-27-30-32 mm
- In custodia
- peso 3,6 kg

RICAMBI

BGS articolo	DESCRIZIONE
BGS 1219-LEER	CUSTODIA VUOTA

SATINATE



PRO+ CV POLIGONALE

BGS articolo	DESCRIZIONE
BGS 30100	SET 25 PEZZI, CHIAVI COMBINATE, 6-32 MM

CARATTERISTICHE

- finitura cromata **satinata**
- **forgiate a freddo**
- misure: 6-7-8-9-10-11-12-13-14-15-16-17-18-19-20-21-22-23-24-25-26-27-28-30-32 mm
- in espositore
- peso 5,9 kg

POLLICI

SATINATE



PRO+ CV POLIGONALE

BGS articolo	DESCRIZIONE
BGS 30101	SET 25 PEZZI, CHIAVI COMBINATE, IN POLLICI, 1/4" - 1 1/4"

CARATTERISTICHE

- finitura cromata **satinata**
- **forgiate a freddo**
- misure: 1/4" - 9/32" - 5/16" - 11/32" - 3/8" - 7/16" - 15/32" - 1/2" - 9/16" - 19/32" - 5/8" - 11/16" - 23/32" - 3/4" - 25/32" - 13/16" - 7/8" - 29/32" - 15/16" - 1" - 1" 1/32" - 1" 1/16" - 1 1/8" - 1" 3/16" - 1" 1/4"
- In espositore
- peso 6,0 kg

XXS



PRO+ CV POLIGONALE

CHIAVI COMBINATE CROMATE
CHROM-VANADIUM DIN 3113 TUV/GS
TIPO CORTO

BGS articolo	mm	L mm	
BGS 30761	10	95	1
BGS 30760	11	103	1
BGS 30762	12	105	1
BGS 30763	13	106	1
BGS 30764	14	116	1
BGS 30775	15	130	1
BGS 30776	16	130	1
BGS 30765	17	135	1
BGS 30778	18	140	1
BGS 30779	19	142	1

XXS



PRO+ CV POLIGONALE

BGS articolo	DESCRIZIONE
BGS 1188	SET 10 PEZZI, CHIAVI COMBINATE TIPO CORTO, 10-19 MM

CARATTERISTICHE

- la lunghezza ridotta rende questo attrezzo perfetto per lavorare in spazi ristretti
- finitura satinata cromata
- misure: 10 - 11 - 12 - 13 - 14 - 15 - 16 - 17 - 18 - 19 mm
- In custodia
- peso 900 g

POLLICI

XXS



PRO+ CV POLIGONALE

BGS articolo	DESCRIZIONE
BGS 32140	SET 8 PEZZI, CHIAVI COMBINATE, TIPO CORTO, IN POLLICI, 3/8" - 7/8"

CARATTERISTICHE

- finitura cromata **satinata**
- tipo corto
- misure: 3/8" - 7/16" - 1/2" - 9/16" - 5/8" - 11/16" - 3/4" - 7/8"
- In custodia
- peso 860 g

CHIAVI COMBINATE



XXL EXTRA LUNGHE



POLIGONALE

**CHIAVI COMBINATE XXL
CHROM-VANADIUM EXTRA LUNGHE
FINITURA CROMATA LUCIDA**

articolo	mm	L mm	
1199-10	10	190	1
1199-11	11	200	1
1199-12	12	220	1
1199-13	13	240	1
1199-14	14	260	1
1199-15	15	280	1
1199-16	16	290	1
1199-17	17	320	1
1199-18	18	330	1
1199-19	19	350	1

XXL EXTRA LUNGHE



PRO+ CV POLIGONALE

**CHIAVI COMBINATE XXL
CHROM-VANADIUM EXTRA LUNGHE**

articolo	mm	L mm	
BGS 1228-6	6	130	1
BGS 1228-7	7	135	1
BGS 1228-8	8	145	1
BGS 1228-9	9	155	1
BGS 1228-10	10	170	1
BGS 1228-11	11	180	1
BGS 1228-12	12	195	1
BGS 1228-13	13	205	1
BGS 1228-14	14	220	1
BGS 1228-15	15	230	1
BGS 1228-16	16	240	1
BGS 1228-17	17	255	1
BGS 1228-18	18	265	1
BGS 1228-19	19	280	1
BGS 1229-21	21	300	1
BGS 1229-22	22	310	1
BGS 1229-24	24	335	1
BGS 1229-27	27	355	1
BGS 1229-30	30	420	1
BGS 1229-32	32	435	1

CARATTERISTICHE

- finitura cromata lucida

XXL EXTRA LUNGHE



PRO+ CV POLIGONALE

articolo	DESCRIZIONE
BGS 1228	SET 14 PEZZI, CHIAVI COMBINATE EXTRA LUNGHE, 6-19 MM

CARATTERISTICHE

- finitura cromata lucida
- extra-lunghe (lunghezza): 6 mm (125 mm), 7 mm (135 mm), 8 mm (145 mm), 9 mm (155 mm), 10 mm (170 mm), 11 mm (180 mm), 12 mm (195 mm), 13 mm (205 mm), 14 mm (220 mm), 15 mm (230 mm), 16 mm (240 mm), 17 mm (255 mm), 18 mm (265 mm), 19 mm (280 mm)
- forgiate a freddo
- In custodia
- peso 1,5 kg

RICAMBI

articolo	DESCRIZIONE
BGS 1228-LEER	CUSTODIA VUOTA

XXL EXTRA LUNGHE

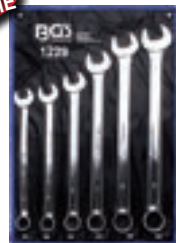

PRO+ CV POLIGONALE

articolo	DESCRIZIONE
BGS 1229	SET 6 PEZZI, CHIAVI COMBINATE XXL EXTRA LUNGHE, 21-32 MM

CARATTERISTICHE

- finitura cromata lucida
- extra-lunghe (lunghezza): 21 mm (300 mm), 22 mm (310 mm), 24 mm (335 mm), 27 mm (355 mm), 30 mm (420 mm), 32 mm (435 mm)
- forgiate a freddo
- In custodia
- peso 3,6 kg

RICAMBI

articolo	DESCRIZIONE
BGS 1229-LEER	CUSTODIA VUOTA

NOTE



CHIAVI COMBINATE CON BOCCA POLIGONALE CURVA 10° CHROM-VANADIUM

BGS articolo	mm	L mm	
BGS 30106	6	100	1
BGS 30107	7	110	1
BGS 30108	8	120	1
BGS 30109	9	130	1
BGS 30110	10	140	1
BGS 30111	11	150	1
BGS 30112	12	160	1
BGS 30113	13	170	1
BGS 30114	14	180	1
BGS 30115	15	190	1
BGS 30116	16	200	1
BGS 30117	17	210	1
BGS 30118	18	220	1
BGS 30119	19	230	1
BGS 30120	20	250	1
BGS 30121	21	260	1
BGS 30122	22	260	1
BGS 30123	23	270	1
BGS 30124	24	280	1
BGS 30125	25	290	1
BGS 30126	26	290	1
BGS 30127	27	310	1
BGS 30128	28	320	1
BGS 30129	29	330	1
BGS 30130	30	340	1
BGS 30132	32	360	1
BGS 30134	34	405	1
BGS 30136	36	450	1
BGS 30141	41	525	1
BGS 30146	46	580	1
BGS 30155	55	615	1
BGS 30160	60	655	1



PRO+ CV POLIGONALE

BGS articolo	DESCRIZIONE
BGS 30301	SET 12 PEZZI, CHIAVI COMBINATE BOCCA POLIGONALE CURVA 10°, 6-22 MM

CARATTERISTICHE

- misure: 6 - 7 - 8 - 9 - 10 - 11 - 12 - 13 - 14 - 17 - 19 - 22 mm
- estremità con anello a sfasatura profonda
- finitura satinata cromata, anello ed estremità aperta lucide
- **forgiate a freddo**
- in custodia
- peso 1,3 kg



PRO+ CV POLIGONALE

BGS articolo	DESCRIZIONE
BGS 30302	SET 17 PEZZI, CHIAVI COMBINATE BOCCA POLIGONALE CURVA 10°, 8-27 MM

CARATTERISTICHE

- misure: 8 - 9 - 10 - 11 - 12 - 13 - 14 - 15 - 16 - 17 - 18 - 19 - 20 - 21 - 22 - 24 - 27 mm
- estremità con anello a sfasatura profonda
- finitura satinata cromata, anello ed estremità aperta lucide
- **forgiate a freddo**
- in custodia
- peso 3,3 kg

MILLIMETRI E POLLICI



PRO+ CV POLIGONALE

BGS articolo	DESCRIZIONE
BGS 32500	ASSORTIMENTO 50 PEZZI, CHIAVI, MISURE METRICHE E IN POLLICI

CARATTERISTICHE

- finitura cromata satinata
- forgiate a freddo
- 20 chiavi combinate:
 - 10, 11, 12, 13, 14, 15, 16, 17, 18, 19 mm;
 - 1/4", 5/16", 3/8", 7/16", 1/2", 9/16", 5/8", 11/16", 3/4", 7/8"
- 10 chiavi tipo C:
 - 8 x 10, 11 x 13, 14 x 15, 17 x 19, 21 x 22 mm;
 - 5/16" x 3/8", 7/16" x 1/2", 9/16" x 5/8", 11/16" x 3/4", 13/16" x 7/8"
- 10 chiavi tipo S:
 - 10 x 11, 12 x 13, 14 x 15, 16 x 17, 18 x 19 mm;
 - 3/8" x 13/32", 7/16" x 1/2", 9/16" x 19/32", 5/8" x 11/16", 11/16" x 3/4"
- 10 chiavi combinate tipo corto:
 - 10, 12, 13, 14, 17 mm;
 - 3/8", 7/16", 1/2", 9/16", 5/8"
- In custodia
- peso 6,2 kg

5 CHIAVI COMBinate - SUPPORTI



EXTRA SOTTILI

ESAGONO **PRO+** **CV**

BGS articolo	DESCRIZIONE
BGS 8646	SET 8 PEZZI, CHIAVI COMBinate, EXTRA-SOTTILI 4 - 10 MM

- CARATTERISTICHE**
- ideali per lavorare in spazi ridotti
 - lato anello con impronta esagonale piegato a 20°
 - misure: 4 - 5 - 5,5 - 6 - 7 - 8 - 9 - 10 mm
 - comprende le seguenti chiavi:
 - forchetta 3.2 mm / anello: 4 mm
 - forchetta 4 mm / anello: 5 mm
 - forchetta 5 mm / anello: 5.5 mm
 - forchetta 5.5 mm / anello: 6 mm
 - forchetta 6 mm / anello: 7 mm
 - forchetta 7 mm / anello: 8 mm
 - forchetta 8 mm / anello: 9 mm
 - forchetta 9 mm / anello: 10 mm
 - peso 90 g

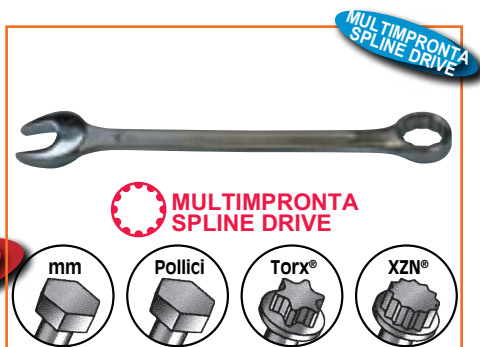

MULTIMPRONTA SPLINE DRIVE



CHIAVI COMBinate CROMATE MULTIMPRONTA CHROM-VANADIUM DIN 3113

#FERMEC articolo	mm	L mm	
44819-8	8	140	1
44819-9	9	155	1
44819-10	10	160	1
44819-11	11	165	1
44819-12	12	170	1
44819-13	13	180	1
44819-14	14	190	1
44819-15	15	200	1
44819-16	16	205	1
44819-17	17	225	1
44819-18	18	235	1
44819-19	19	250	1



PRO+

SUPPORTO PER CHIAVI COMBinate

BGS articolo	DESCRIZIONE
BGS 1176	12 VANI
BGS 1177	15 VANI



PRO+

SUPPORTO DA 8 VANI PER CHIAVI COMBinate

BGS articolo	DESCRIZIONE
BGS 1175	SUPPORTO DA 8 VANI PER CHIAVI COMBinate



NEW

ESAGONO **PRO+**

BGS articolo	DESCRIZIONE
BGS 6663	SET 5 PEZZI, CHIAVI DOPIPO ANELLO E LEVA IN PLASTICA

- CARATTERISTICHE**
- aiuta a prevenire danni ai trattamenti superficiali
 - previene danni a viti cromate o anodizzate, dadi, listelli, anelli ornamentali, copricerchi, ecc...
 - realizzato in plastica composita
 - comprende:
 - 4 chiavi a doppio anello, profilo esagonale, misure:
 - metriche: 6, 8, 10, 12, 13 mm
 - in pollici: 3/8", 7/16", 1/2"
 - 1 leva
 - peso: 180 g



NEW

PRO+

SUPPORTO PER CHIAVI COMBinate

BGS articolo	DESCRIZIONE
BGS 6781	12 VANI
BGS 6782	8 VANI

- CARATTERISTICHE**
- adatto per fissaggio a muro
 - dimensioni (lunghezza x larghezza x altezza):
 - BGS 6781: 280 X 130 X 37 mm
 - BGS 6782: 220 X 130 X 37 mm
 - impugnatura in materiale bi-componente
 - materiale: plastica
 - colore: nero

EXTRA LUNGHE



PRO+ CV POLIGONALE

**CHIAVI POLIGONALI DOPPIE DIRITTE
CROMATE EXTRA LUNGHE**

BGS articolo	mm	L mm	
BGS 1186-10X11	10 x 11	290	1
BGS 1186-12X14	12 x 14	330	1
BGS 1186-13X15	13 x 15	370	1
BGS 1186-16X18	16 x 18	410	1
BGS 1186-17X19	17 x 19	410	1
BGS 1186-21X23	21 x 23	420	1
BGS 1186-22X24	22 x 24	435	1

EXTRA LUNGHE



CV PRO+ POLIGONALE

BGS articolo	DESCRIZIONE
BGS 1187	SET 5 PEZZI, CHIAVI DOPPIO ANELLO EXTRA-LUNGHE, 8 - 19 MM

CARATTERISTICHE

- misure:
 - 8x10 (lung. 235 mm) - 11x13 (lung. 330 mm)
 - 14x15 (lung. 370 mm) - 16x17 (lung. 410 mm)
 - 18x19 mm (lung. 410 mm)
- tipo dritto
- finitura cromata e lucida
- in custodia
- peso 1,5 kg

RICAMBI

BGS articolo	DESCRIZIONE
BGS 1187-LEER	CUSTODIA VUOTA



POLIGONALE PRO+ CV

**CHIAVI POLIGONALI DOPPIE,
DRITTE E PIATTE
SATINATE CROMATE**

BGS articolo	mm	L mm	
BGS 30330	6 x 7	100	1
BGS 30331	8 x 9	115	1
BGS 30332	10 x 11	132	1
BGS 30333	12 x 13	145	1
BGS 30334	14 x 15	160	1
BGS 30335	16 x 17	169	1
BGS 30336	18 x 19	186	1
BGS 30337	20 x 22	205	1
BGS 30338	24 X 27	257	1
BGS 30339	30 X 32	316	1



POLIGONALE PRO+ CV

BGS articolo	DESCRIZIONE
BGS 30300	SET 8 PEZZI, CHIAVI A DOPPIO ANELLO, DRITTE, 6-22 MM

CARATTERISTICHE

- **dritte e piatte**
- misure:
 - 6x7, 8x9, 10x11, 12x13, 14x15, 16x17, 18x19, 20x22 mm
- in custodia
- peso 620 g

RICAMBI

BGS articolo	DESCRIZIONE
BGS 30300-LEER	CUSTODIA VUOTA

NOTE

5 CHIAVI A FORCHETTA DOPPIE



PRO+ CV

BGS articolo	DESCRIZIONE
BGS 9019	SET 7 PEZZI, CHIAVI FISSE A FORCHETTA DOPPIE, EXTRA-SOTTILI, 6-23 MM

CARATTERISTICHE

- particolarmente adatto per spazi ristretti
- comprende:
 - 6 x 7 mm, lunghezza 101 mm
 - 8 x 9 mm, lunghezza 114 mm
 - 10 x 12 mm, lunghezza 125 mm
 - 11 x 13 mm, lunghezza 138 mm
 - 14 x 17 mm, lunghezza 157 mm
 - 19 x 21 mm, lunghezza 178 mm
 - 22 x 23 mm, lunghezza 200 mm
- spessore chiavi: 3 mm
- finitura cromata
- peso 390 g



BGS articolo	DESCRIZIONE
BGS 1239	SET 7 PEZZI, MINI -CHIAVI FISSE A FORCHETTA DOPPIE, 3 - 5,5 MM

CARATTERISTICHE

- misure: 3 - 3,2 - 3,5 - 4 - 4,5 - 5 - 5,5 mm
- peso 80 g



PRO+ CV

CHIAVI FISSE A FORCHETTA DOPPIE
DIN 3110 - TUV/GS GERMANY
CHROM VANADIUM
TESTA LUCIDA

BGS articolo	mm	L mm	
BGS 30605	5 X 5,5	150	1
BGS 1184-6X7	6 X 7	125	1
BGS 1184-8X9	8 X 9	133	1
BGS 1184-10X11	10 X 11	148	1
BGS 1184-10X13	10 X 13	171	1
BGS 1184-12X13	12 X 13	168	1
BGS 1184-14X15	14 X 15	182	1
BGS 30611	14 X 17	270	1
BGS 1184-16X17	16 X 17	196	1
BGS 30617	17 X 19	270	1
BGS 1184-18X19	18 X 19	216	1
BGS 30623	19 X 22	287	1
BGS 1184-20X22	20 X 22	231	1
BGS 1184-21X23	21 X 23	241	1
BGS 30622	22 X 24	300	1
BGS 1184-24X27	24 X 27	260	1
BGS 1184-25X28	25 X 28	271	1
BGS 30627	27 X 30	313	1
BGS 30632	27 X 32	295	1
BGS 1184-30X32	30 X 32	294	1
BGS 30631	30 X 34	299	1
BGS 1184-36X41	36 X 41	354	1

TOP



PRO+ CV

BGS articolo	Nr. CHIAVI	MISURE
BGS 1182	8	6X7 - 20X22 MM
BGS 1184	12	6X7 - 30X32 MM

CARATTERISTICHE

- finitura cromata
- estremità lucide
- BGS 1182: 6x7, 8x9, 10x11, 12x13, 14x15, 16x17, 18x19, 20x22 mm
- BGS 1184: 6x7, 8x9, 10x11, 12x13, 14x15, 16x17, 18x19, 20x22, 21x23, 24x27, 25x28, 30x32 mm
- in custodia

RICAMBI

BGS articolo	DESCRIZIONE
BGS 1184-LEER	CUSTODIA VUOTA PER SET BGS 1184



PRO+ CV

BGS articolo	DESCRIZIONE
BGS 1179	SET 6 PEZZI, CHIAVI FISSE A FORCHETTA DOPPIE, CONFORMI DIN 3110, 6X7, 17X19 MM

CARATTERISTICHE

- finitura cromata
- estremità lucidate
- misure: 6x7 - 8x9 - 10x11 - 12x13 - 14x15 - 17x19 mm
- in scatola di cartone
- peso 530 g



**CHIAVI FISSE A FORCHETTA
CON UNA BOCCA ZINCATE
DIN 3114 CON FORO NEL MANICO**

FEEMEC articolo	mm	L mm	
894-17	17	150	1
894-19	19	170	1
894-22	22	195	1
894-24	24	215	1
894-27	27	240	1
894-30	30	260	1
894-32	32	275	1
894-36	36	305	1
894-38	38	340	1
894-41	41	340	1
894-46	46	380	1
894-50	50	410	1
894-55	55	440	1
894-60	60	510	1
894-65	65	510	1
894-70	70	570	1
894-75	75	610	1
894-80	80	650	1
894-85	85	680	1
894-90	90	700	1
894-95	NEW 95	850	1
894-100	NEW 100	850	1
894-105	NEW 105	1000	1

**DISPONIBILI
A RICHIESTA,
NELLE STESSE
MISURE, CHIAVI
POLIGONALI
SINGOLE DRITTE**



**serie
ALTA RESISTENZA**



**CHIAVI FISSE A FORCHETTA
CON UNA BOCCA NERE
SERIE ALTA RESISTENZA**

BGS articolo	mm	L mm	
BGS 34206	6	73	1
BGS 34207	7	78	1
BGS 34208	8	94	1
BGS 34209	9	100	1
BGS 34210	10	104	1
BGS 34211	11	104	1
BGS 34212	12	123	1
BGS 34213	13	133	1
BGS 34214	14	140	1
BGS 34215	15	140	1
BGS 34216	16	145	1
BGS 34217	17	155	1
BGS 34218	18	155	1
BGS 34219	19	170	1
BGS 34221	21	190	1
BGS 34222	22	194	1
BGS 34223	23	194	1
BGS 34224	24	210	1
BGS 34225	25	210	1
BGS 34227	27	240	1
BGS 34230	30	262	1
BGS 34232	32	272	1
BGS 34234	34	282	1
BGS 34236	36	297	1
BGS 34238	38	297	1
BGS 34241	41	337	1
BGS 34246	46	372	1
BGS 34250	50	399	1
BGS 34255	55	450	1
BGS 34260	60	473	1
BGS 34265	65	528	1
BGS 34270	70	585	1
BGS 34275	75	604	1
BGS 34280	80	665	1
BGS 34285	85	665	1
BGS 34290	NEW 90	665	1
BGS 34295	NEW 95	860	1



NEW



**CHIAVI FISSE A FORCHETTA CON UNA
BOCCA ISOLATE**

FEEMEC articolo	DESCRIZIONE
FM 200-6	6
FM 200-7	7
FM 200-8	8
FM 200-9	9
FM 200-10	10
FM 200-11	11
FM 200-12	12
FM 200-13	13
FM 200-14	14
FM 200-15	15
FM 200-16	16
FM 200-17	17
FM 200-18	18
FM 200-19	19
FM 200-21	21
FM 200-22	22
FM 200-24	24
FM 200-27	27
FM 200-30	30
FM 200-32	32

CARATTERISTICHE

- IEC 60900
- 1000 V



BGS articolo	DESCRIZIONE
BGS 7159	SET 5 PEZZI, CHIAVI A FORCHETTA ISOLATE VDE, 7-14 MM

CARATTERISTICHE

- idonee per lavorare con dispositivi elettrici
- misure: 7 - 8 - 10 - 12 - 14 mm
- conforme VDE
- peso 340 g



POLIGONALE **PRO+** **CV**

**CHIAVI POLIGONALI CROMATE DOPPIE
TEMPERATE, CROMATE
ESTREMITÀ LUCIDATE**

BGS articolo	mm	L mm	
BGS 1214-6X7	6 X 7	185	1
BGS 1214-8X9	8 X 9	201	1
BGS 1214-10X11	10 X 11	213	1
BGS 30211	10 X 13	220	1
BGS 1214-12X13	12 X 13	231	1
BGS 30213	13 X 17	270	1
BGS 1214-14X15	14 X 15	241	1
BGS 30215	14 X 17	269	1
BGS 1214-16X17	16 X 17	261	1
BGS 1214-18X19	18 X 19	282	1
BGS 30223	19 X 22	330	1
BGS 1214-20X22	20 X 22	309	1
BGS 1214-21X23	21 X 23	320	1
BGS 1214-24X27	24 X 27	341	1
BGS 1214-25X28	25 X 28	341	1
BGS 1214-30X32	30 X 32	371	1
BGS 30236	36 X 41	452	1
BGS 30246	46 X 50	530	1



POLIGONALE **PRO+** **CV**

BGS articolo	DESCRIZIONE
BGS 1209	SET 8 PEZZI, POLIGONALI CROMATE DOPPIE CURVE, 6 - 22 MM

CARATTERISTICHE

- misure: 6x7, 8x9, 10x11, 12x13, 14x15, 16x17, 18x19, 20x22 mm
- finitura cromata
- in custodia
- peso 1,3 kg



PRO+ **CV** **POLIGONALE**

BGS articolo	DESCRIZIONE
BGS 1212	SET 8 PEZZI, CHIAVI A DOPPIO ANELLO "DEEP CRANK", 6X7-20X22 MM

CARATTERISTICHE

- finitura cromata
- estremità lucide
- misure: 6x7, 8x9, 10x11, 12x13, 14x15, 16x17, 18x19, 20x22 mm
- in supporto da parete in plastica
- peso 1,3 kg



POLIGONALE **PRO+** **CV**

BGS articolo	DESCRIZIONE
BGS 1213	SET 8 PEZZI, POLIGONALI CROMATE DOPPIE CURVE, 6 - 22 MM

CARATTERISTICHE

- misure: 6x7, 8x9, 10x11, 12x13, 14x15, 16x17, 18x19, 20x22 mm
- finitura cromata
- in scatola di cartone
- peso 1,3 kg



POLIGONALE **PRO+** **CV**

BGS articolo	DESCRIZIONE
BGS 1214	SET 12 PEZZI, POLIGONALI CROMATE DOPPIE CURVE, 6 - 32 MM

CARATTERISTICHE

- misure: 6x7, 8x9, 10x11, 12x13, 14x15, 16x17, 18x19, 20x22, 21x23, 24x27, 25x28, 30x32 mm
- finitura cromata
- in custodia
- peso 3,3 kg

RICAMBI

BGS articolo	DESCRIZIONE
BGS 1214-LEER	CUSTODIA VUOTA

CHIAVI POLIGONALI DOPPIE

5 CHIAVI POLIGONALI DOPPIE

CHIAVI POLIGONALI DOPPIE

POLLICI

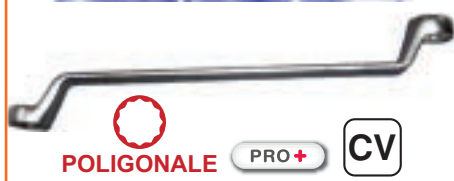

BGS articolo	DESCRIZIONE
BGS 32105	SET 6 PEZZI, CHIAVI A DOPPIO ANELLO, SFASAMENTO 75°, FORMATI SAE, 1/4"-3/4"

CARATTERISTICHE	
<ul style="list-style-type: none"> • misure: 1/4" x 5/16", 3/8" x 7/16", 1/2" x 9/16", 9/16" x 5/8", 19/32" x 11/16", 11/16" x 3/4" • tipo con estremità con anello a sfasatura profonda • finitura satinata cromata, estremità lucide • in conformità con DIN 838 • in custodia • peso 1,0 kg 	



CHIAVI POLIGONALI PER STARTER SATINATE CROMATE

BGS articolo	mm	L mm	
BGS 30721	8 x 10	134	1
BGS 30722	11 x 13	150	1
BGS 30723	14 x 15	168	1
BGS 30724	17 x 19	207	1
BGS 30725	21 x 22	231	1



BGS articolo	DESCRIZIONE
BGS 1215	SET 3 PEZZI, CHIAVI POLIGONALI PER STARTER, 10X13 - 17X19 MM

CARATTERISTICHE	
<ul style="list-style-type: none"> • finitura satinata cromata • misure: 10x13, 14x15, 17x19 mm • forgiate a freddo • in custodia • peso 520 g 	



BGS articolo	DESCRIZIONE
BGS 1217	SET 5 PEZZI, CHIAVI POLIGONALI PER STARTER 8X10 - 21X22 MM

CARATTERISTICHE	
<ul style="list-style-type: none"> • finitura satinata cromata • misure: 8x10, 11x13, 14x15, 17x19, 21x22 mm • forgiate a freddo • in custodia • peso 870 g 	



BGS articolo	DESCRIZIONE
BGS 1222	SET 5 PEZZI, CHIAVI POLIGONALI PER STARTER IN POLLICI, 1/4" - 7/8"

CARATTERISTICHE	
<ul style="list-style-type: none"> • finitura satinata cromata • misure: 1/4"x5/16" - 3/8"x7/16" - 1/2"x9/16" - 5/8"x11/16" - 3/4"x7/8" • forgiate a freddo • in custodia • peso 840 g 	



POLIGONALE **PRO+** **CV**

CHIAVI POLIGONALI PER STARTER SATINATE CROMATE

BGS articolo	mm	L mm	
BGS 30741	10 x 11	138	1
BGS 30742	12 x 13	154	1
BGS 30743	14 x 15	189	1
BGS 30744	16 x 17	221	1
BGS 30745	18 x 19	235	1



POLIGONALE **PRO+** **CV**

BGS articolo	DESCRIZIONE
BGS 1216	SET 5 PEZZI, CHIAVI DOPPIO ANELLO TIPO "S", 10X11-18X19 MM

CARATTERISTICHE

- finitura satinata cromata
- misure: 10x11, 12x13, 14x15, 16x17, 18x19 mm
- forgiate a freddo
- in custodia
- peso 850 g

POLLICI



POLIGONALE **PRO+** **CV**

BGS articolo	DESCRIZIONE
BGS 32150	SET 5 PEZZI, CHIAVI DOPPIO ANELLO TIPO "S", FORMATI IN POLLICI, 3/8" - 3/4"

CARATTERISTICHE

- finitura satinata cromata
- misure: 3/8 x 5/16" - 7/16 x 1/2" - 9/16 x 19/32" - 5/8" x 11/16" - 11/16 x 3/4"
- forgiate a freddo
- in custodia
- peso 750 g

NEW



POLIGONALE

1000 V 

CHIAVI DISASSATE, CON ANELLO POLIGONALE, ISOLATE

FEIMEC articolo	DESCRIZIONE
FM 210-6	6
FM 210-7	7
FM 210-8	8
FM 210-9	9
FM 210-10	10
FM 210-11	11
FM 210-12	12
FM 210-13	13
FM 210-14	14
FM 210-15	15
FM 210-16	16
FM 210-17	17
FM 210-18	18
FM 210-19	19
FM 210-21	21
FM 210-22	22
FM 210-24	24
FM 210-27	27
FM 210-30	30
FM 210-32	32

CARATTERISTICHE

- IEC 60900
- 1000 V

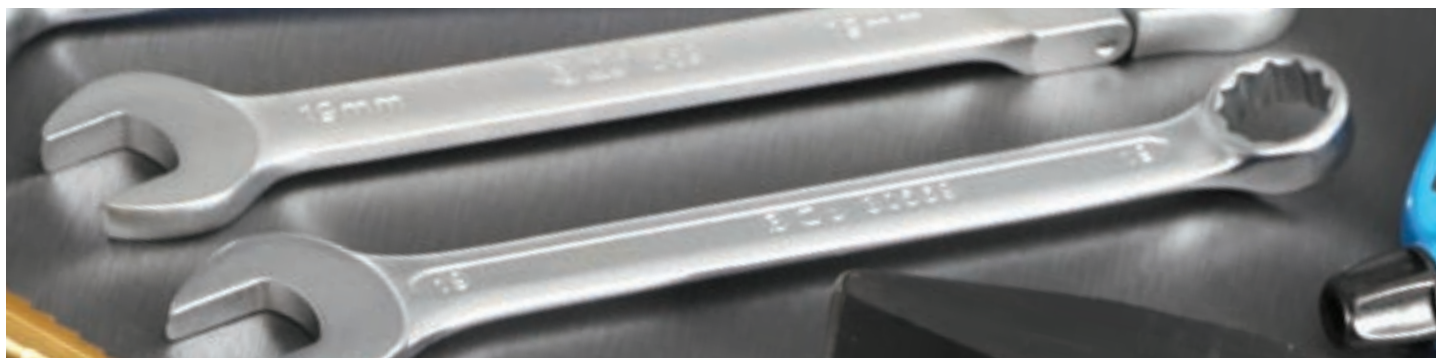



SET 4 PEZZI CHIAVI TORX FEMMINA A MEZZA LUNA IN BLISTER SATINATE E6 X E8 - E10 X E12 - E14 X E18 - E20 X E24



articolo	descrizione
22624	Set 4 pezzi, chiavi torx a mezzaluna



PRO+



CHIAVI A DOPPIO ANELLO TORX SATINATE CROMATE DOPPIE CURVE

BGS articolo	TORX	L mm	box
BGS 2281-6X8	E6 X E8	145	1
BGS 2281-10X12	E10 X E12	270	1
BGS 2281-14X18	E14 X E18	210	1
BGS 2281-20X24	E20 X E24	255	1

CARATTERISTICHE

- finitura satinata cromata



PRO+



BGS articolo	DESCRIZIONE
BGS 2281	SERIE 6 PEZZI, CHIAVI TORX FEMMINA DOPPIE CURVE, E6-E24

CARATTERISTICHE

- finitura satinata cromata
- misure: E6xE8, E7xE11, E10xE12, E14xE18, E16xE22, E20xE24
- peso 900



PRO+



CHIAVI A DOPPIO ANELLO TORX SATINATE CROMATE DRITTE E PIATTE

BGS articolo	TORX	L mm	box
BGS 2260	E6 X E8	110	1
BGS 2265	E7 X E11	138	1
BGS 2261	E10 X E12	137	1
BGS 2262	E14 X E18	179	1
BGS 2266	E16 X E22	222	1
BGS 2263	E20 X E24	224	1



PRO+



BGS articolo	DESCRIZIONE
BGS 2264	SET 4 PEZZI, CHIAVI A DOPPIO ANELLO TIPO TORX, E6XE8-E20XE24

CARATTERISTICHE

- finitura satinata cromata
- dritte e piatte
- misure: E6xE8, E10xE12, E14xE18, E20xE24
- peso 380 g



PRO+



BGS articolo	DESCRIZIONE
BGS 2268	SET 6 PEZZI, CHIAVI TORX FEMMINA DOPPIE, E6-E24

CARATTERISTICHE

- finitura satinata cromata
- misure: E6xE8, E7xE11, E10xE12, E14xE18, E16xE22, E20xE24
- peso 550 g

PRO+
**CHIAVE A RULLINO
 IMPUGNATURA MORBIDA IN GOMMA**

BGS articolo	mm	L mm
BGS 1440	0-19	150 MM, 6"
BGS 1441	0-25	200 MM, 8"
BGS 1442	0-30	250 MM, 10"
BGS 1443	0-36	300 MM, 12"

CARATTERISTICHE

- finitura satinata nichelata
- impugnatura morbida in gomma
- con scala in millimetri

PRO+

BGS articolo	DESCRIZIONE
BGS 1446	SET 3 PEZZI, CHIAVI A RULLINO

CARATTERISTICHE

- comprende le seguenti chiavi:
 - lunghezza 150 mm, 0 - 19 mm (BGS 1440)
 - lunghezza 200 mm, 0 - 25 mm (BGS 1441)
 - lunghezza 250 mm, 0 - 30 mm (BGS 1442)
- impugnature rivestite in gomma
- in custodia
- peso 1,0 kg

NEW

BGS articolo	DESCRIZIONE
BGS 6839	CHIAVE A RULLINO IMPUGNATURA MORBIDA IN GOMMA, MAX 38 MM

CARATTERISTICHE

- con scala in millimetri
- ideale per piccole valigette portautensili
- tipo extra corto
- apertura massima della chiave: 38 mm
- lunghezza: 160 mm
- impugnatura in materiale bi-componente
- peso 250 g

CHIAVE A RULLINO

BGS articolo	mm	L mm
BGS 1470	0-19	150 MM, 6"
BGS 1471	0-25	200 MM, 8"
BGS 1472	0-29	250 MM, 10"
BGS 1473	0-35	300 MM, 12"
BGS 1474	0-40	380 MM, 15"
BGS 1476	0-62	600 MM, 24"

CARATTERISTICHE

- finitura cromata, lucidata

IDONEA PER USO SU:

ESAGONO

**ESAGONO
 ROVINATI**

12 PUNTE

QUADRO

TUBI

TORX

CHIAVI SPECIALI AUTOSERRANTE

BGS articolo	DESCRIZIONE	L mm
7 SSH 06	Ø 10-16 MM	150
7 SSH 01	Ø 10-30 MM	250

CARATTERISTICHE

- idonea per presa su tubi
- anche per uso su dadi: esagonali, esagonali rovinati, torx, 12 punte, quadro
- per Ø
 - 7 SSH 06: 10-16 mm
 - 7 SSH 01: 10-30 mm
- ideale per il settore automotive
- autoserrante
- ganasce dentate antiscivolo

CRICCHETTO

CV

POLIGONALE



CHIAVI COMBINATE A CRICCHETTO POLIGONALE FINITURA LUCIDA

articolo	mm	L mm	
CW-6	6	135	1
CW-7	7	135	1
CW-8	8	136	1
CW-9	9	143	1
CW-10	10	160	1
CW-11	11	168	1
CW-12	12	174	1
CW-13	13	180	1
CW-14	14	193	1
CW-15	15	200	1
CW-16	16	216	1
CW-17	17	233	1
CW-18	18	239	1
CW-19	19	250	1
CW-20	20	260	1
CW-21	21	285	1
CW-22	22	285	1
CW-24	24	325	1
CW-25	25	325	1
CW-27	27	354	1
CW-30	30	425	1
CW-32	32	425	1
CW-36	36	490	1
CW-41	41	540	1
CW-46	46	600	1
CW-50	50	600	1



POLIGONALE

CHIAVI COMBINATE A CRICCHETTO

- SET 7 PZ. 8-10-12-13-14-17-19 MM
- SET 12 PZ. 8-9-10-11-12-13-14-15-16-17-18-19 MM

articolo	Descrizione	
CW-87419	SET 7 PEZZI	1
CW-81219	SET 12 PEZZI	1



CRICCHETTO

PRO+ CV POLIGONALE

CHIAVI COMBINATE A CRICCHETTO POLIGONALE FINITURA SATINATA

articolo	mm	L mm
BGS 6508	8	196
BGS 6509	9	206
BGS 6510	10	213
BGS 6511	11	219
BGS 6512	12	220
BGS 6513	13	252
BGS 6514	14	263
BGS 6515	15	274
BGS 6516	16	283
BGS 6517	17	295
BGS 6518	18	306
BGS 6519	19	319
BGS 6521	21	379
BGS 6522	22	380
BGS 6524	24	420
BGS 6527	27	463
BGS 6530	30	504
BGS 6532	32	523

CARATTERISTICHE

- cricchetto 72 denti
- finitura: cromata satinata



CV

PRO+

SET CHIAVI COMBINATE A CRICCHETTO

articolo	NR. PEZZI	MISURE MM
BGS 6540	8	8 - 19
BGS 6541	12	8 - 19
BGS 6542	NEW 13	8 - 32

CARATTERISTICHE

- meccanismo a cricchetto a 72 denti
- finitura cromata satinata
- misure:
 - BGS 6540: 8 - 10 - 12 - 13 - 14 - 15 - 17 - 19 mm
 - BGS 6541: 8 - 9 - 10 - 11 - 12 - 13 - 14 - 15 - 16 - 17 - 18 - 19 mm
 - BGS 6542: 8 - 10 - 12 - 13 - 14 - 17 - 19 - 21 - 22 - 24 - 27 - 30 - 32 mm



PRO+

CV

1/6

BGS articolo

DESCRIZIONE

BGS 6502

**SET 6 PEZZI,
CHIAVI COMBINATE
A CRICCHETTO
REVERSIBILE,
8-13 MM**

CARATTERISTICHE

- 72 denti
- finitura: satinata cromata
- comprende:
 - chiave combinata a cricchetto 8 mm (BGS 6508)
 - chiave combinata a cricchetto 9 mm (BGS 6509)
 - chiave combinata a cricchetto 10 mm (BGS 6510)
 - chiave combinata a cricchetto 11 mm (BGS 6511)
 - chiave combinata a cricchetto 12 mm (BGS 6512)
 - chiave combinata a cricchetto 13 mm (BGS 6513)
- cass. vuota per moduli utensili 1/6 (BGS BOX16)
- peso: 520 g

CV **POLIGONALE**

BGS articolo	DESCRIZIONE
BGS 30006	SET 13 PEZZI, CHIAVI COMBinate A CRICCHETTO, 8-32 MM

CARATTERISTICHE

- misure: 8 - 10 - 12 - 13 - 14 - 17 - 19 - 21 - 22 - 24 - 27 - 30 - 32 mm
- meccanismo a cricchetto da 72 denti
- finitura cromata
- peso 6,1 kg

CV **POLIGONALE**

BGS articolo	DESCRIZIONE
BGS 30001	SET 12 PEZZI, CHIAVI COMBinate A CRICCHETTO, 8-19 MM

CARATTERISTICHE

- chiave con anello a cricchetto da 72 denti
- misure: 8 - 9 - 10 - 11 - 12 - 13 - 14 - 15 - 16 - 17 - 18 - 19 mm
- finitura cromata
- peso 1,6 kg

NEW

BGS articolo

BGS articolo	DESCRIZIONE
BGS 30009	SET 22 PEZZI, CHIAVI COMBinate A CRICCHETTO, 6 - 32 MM

CARATTERISTICHE

- in valigetta di alluminio con bordi rinforzati
- meccanismo a cricchetto da 72 denti
- angolo di regolazione: 5°
- finitura: cromata lucida
- comprende:
 - chiavi combinata a cricchetto: 6 - 7 - 8 - 9 - 10 - 11 - 12 - 13 - 14 - 15 - 16 - 17 - 18 - 19 - 20 - 21 - 22 - 23 - 24 - 27 - 30 - 32 mm

RICAMBI

BGS articolo	DESCRIZIONE
BGS 30009-1	CASSETTA VUOTA

EXTRA CORTE

CV **POLIGONALE**

CHIAVI COMBinate A CRICCHETTO POLIGONALE FINITURA LUCIDA

FEIMEC articolo	mm	L mm	
CWS-10	10	96	1
CWS-11	11	100	1
CWS-12	12	104	1
CWS-13	13	108	1
CWS-14	14	114	1
CWS-15	15	118	1
CWS-16	16	122	1
CWS-17	17	128	1
CWS-18	18	132	1
CWS-19	19	138	1

POLLICI

CWS-3/8"	3/8"	96	1
CWS-7/16"	7/16"	100	1
CWS-1/2"	1/2"	108	1
CWS-9/16"	9/16"	114	1
CWS-5/8"	5/8"	122	1
CWS-11/16"	11/16"	128	1
CWS-3/4"	3/4"	138	1

POLIGONALE

SET 10 PEZZI, CHIAVI COMBinate A CRICCHETTO TIPO CORTO MISURE: 10-11-12-13-14-15-16 17- 18-19 MM

FEIMEC articolo	Descrizione	
CWS-1910	SET 10 PEZZI	1

CHIAVI COMBinate A CRICCHETTO



CV POLIGONALE

WRENCHET

EFFETTO CRICCHETTO
Il serraggio avviene senza staccare la chiave dal dado

CHIAVI COMBINATE A CRICCHETTO POLIGONALE E BOCCA FISSA A PRESA RAPIDA WRENCHET

FEARMEC articolo	mm	L mm	
WR 658	8	144	6
WR 659	9	150	6
WR 660	10	158	6
WR 661	11	165	6
WR 662	12	173	6
WR 663	13	182	6
WR 664	14	190	6
WR 665	15	202	6
WR 666	16	215	6
WR 667	17	229	6
WR 668	18	240	6
WR 669	19	252	6
WR 610	5/16"	145	6
WR 612	3/8"	157	6
WR 614	7/16"	163	6
WR 616	1/2"	182	6
WR 618	9/16"	190	6
WR 620	5/8"	215	6
WR 622	11/16"	227	6
WR 624	3/4"	252	6



POLLICI

POLIGONALE

CHIAVI COMBINATE A CRICCHETTO IN POLLICI

- SET 8 PZ. 5/16" - 3/8" - 7/16" - 1/2" - 9/16" - 5/8" - 11/16" - 3/4"

FEARMEC articolo	Descrizione	
FM 61024	SET 8 PEZZI	1



PRO+

SUPPORTO PER CHIAVI COMBINATE

BGS articolo	DESCRIZIONE
BGS 1176	12 VANI
BGS 1177	15 VANI

CARATTERISTICHE

- dimensioni:
 - BGS 1176: 226 x 155 x 23 mm
 - BGS 1176: 297 x 180 x 28 mm
- in plastica nera
- con fori per fissaggio a muro



PRO+

SUPPORTO DA 8 VANI PER CHIAVI COMBINATE

BGS articolo	DESCRIZIONE
BGS 1175	SUPPORTO DA 8 VANI PER CHIAVI COMBINATE

CARATTERISTICHE

- in plastica nera
- per chiavi di misura fino a 20 mm
- meccanismo di chiusura
- peso 70 g



NEW

PRO+

SUPPORTO PER CHIAVI COMBINATE

BGS articolo	DESCRIZIONE
BGS 6781	12 VANI
BGS 6782	8 VANI

CARATTERISTICHE

- adatto per fissaggio a muro
- dimensioni (lunghezza x larghezza x altezza):
 - BGS 6781: 280 X 130 X 37 mm
 - BGS 6782: 220 X 130 X 37 mm
- impugnatura in materiale bi-componente
- materiale: plastica
- colore: nero



REVERSIBILE



CHIAVI COMBINATE A CRICCHETTO POLIGONALE REVERSIBILE E TESTA A 15° FINITURA LUCIDA - LEVA DI INVERSIONE

FEIMEC articolo	mm	L mm	
BW-6	6	135	1
BW-7	7	135	1
BW-8	8	136	1
BW-9	9	143	1
BW-10	10	160	1
BW-11	11	168	1
BW-12	12	174	1
BW-13	13	180	1
BW-14	14	190	1
BW-15	15	200	1
BW-16	16	216	1
BW-17	17	233	1
BW-18	18	239	1
BW-19	19	248	1
BW-20	20	284	1
BW-21	21	284	1
BW-22	22	284	1
BW-24	24	324	1
BW-25	25	324	1
BW-27	27	350	1
BW-30	30	420	1
BW-32	32	420	1



POLIGONALE

CHIAVI COMBINATE A CRICCHETTO REVERSIBILE E TESTA A 15°

- SET 5 PZ. 8-10-13-17-19 MM
- SET 12 PZ. 8-9-10-11-12-13-14-15-16-17-18-19 MM

FEIMEC articolo	Descrizione	
BW-519	SET 5 PEZZI	1
BW-1219	SET 12 PEZZI	1

NEW



REVERSIBILE

PRO+ CV POLIGONALE

CHIAVI COMBINATE A CRICCHETTO POLIGONALE FINITURA SATINATA TESTA A 15° - LEVA DI INVERSIONE

BGS articolo	mm	L mm
BCS 6608	8	195
BCS 6609	9	195
BCS 6610	10	213
BCS 6611	11	195
BCS 6612	12	195
BCS 6613	13	253
BCS 6614	14	195
BCS 6615	15	269
BCS 6616	16	281
BCS 6617	17	296
BCS 6618	18	305
BCS 6619	19	313

CARATTERISTICHE

- cricchetto 72 denti
- finitura: cromata satinata
- reversibili

NEW



BGS articolo	DESCRIZIONE
BGS 30008	SET 12 PEZZI, CHIAVI COMBINATE A CRICCHETTO REVERSIBILI, 8 - 19 MM

CARATTERISTICHE

- chiave con anello a cricchetto da 72 denti
- testa con anello a cricchetto inclinata 15°
- finitura cromata
- misure: 8 - 9 - 10 - 10 - 11 - 12 - 13 - 14 - 15 - 16 - 16 - 17 - 18 - 19 mm
- peso: 1,6 kg



POLIGONALE **PRO+** **CV**

CHIAVI COMBINATE
CRICCHETTO POLIGONALE REVERSIBILE
EXTRA-CORTE
SATINATE CROMATE

BGS articolo	mm	L mm	
BGS 30708	8	88	1
BGS 30709	9	93	1
BGS 30710	10	105	1
BGS 30711	11	120	1
BGS 30712	12	125	1
BGS 30713	13	106	1
BGS 30714	14	120	1
BGS 30715	15	116	1
BGS 30716	16	135	1
BGS 30717	17	125	1
BGS 30718	18	129	1
BGS 30719	19	155	1



PRO+ **CV** **POLIGONALE**

BGS articolo	DESCRIZIONE
BGS 30720	SET 8 PEZZI, CHIAVI COMBINATE CRICCHETTO POLIGONALE REVERSIBILE EXTRA-CORTE, 8 - 19 MM

CARATTERISTICHE

- misure: 8-10-12-13-14-15-17-19 mm
- finitura satinata cromata
- in custodia
- peso 830 g



CON SNODO

CV

POLIGONALE

SNODATE

CHIAVI COMBINATE A CRICCHETTO
POLIGONALE CON SNODO
FINITURA LUCIDA

FERMEC articolo	mm	L mm	
FRW-6	6	135	1
FRW-7	7	135	1
FRW-8	8	136	1
FRW-9	9	143	1
FRW-10	10	160	1
FRW-11	11	168	1
FRW-12	12	174	1
FRW-13	13	180	1
FRW-14	14	193	1
FRW-15	15	200	1
FRW-16	16	216	1
FRW-17	17	233	1
FRW-18	18	239	1
FRW-19	19	250	1
FRW-20	20	250	1
FRW-21	21	260	1
FRW-22	22	285	1
FRW-24	24	320	1
FRW-27	27	355	1
FRW-30	30	420	1
FRW-32	32	420	1



POLIGONALE

CHIAVI COMBINATE A CRICCHETTO
POLIGONALE CON SNODO

- SET 5 PEZZI 8-10-13-17-19 MM
- SET 12 PEZZI 8-9-10-11-12-13-14-15-16-17-18-19 MM

FERMEC articolo	Descrizione	
FRW-198	SET 5 PEZZI	1
FRW-2198	SET 12 PEZZI	1



CON SNODO

SNODATE

PRO+ **CV** **POLIGONALE**

CHIAVI COMBINATE A CRICCHETTO
POLIGONALE CON SNODO
FINITURA SATINATA

BGS articolo	mm	L mm	
BGS 6708	8	194	1
BGS 6709	9	195	1
BGS 6710	10	214	1
BGS 6711	11	195	1
BGS 6712	12	219	1
BGS 6713	13	253	1
BGS 6714	14	195	1
BGS 6715	15	195	1
BGS 6716	16	280	1
BGS 6717	17	298	1
BGS 6718	18	306	1
BGS 6719	19	314	1

CARATTERISTICHE

- cricchetto 72 denti
- finitura: cromata satinata
- snodate 180°

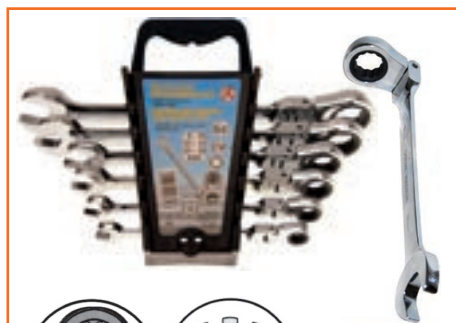

POLIGONALE

SET 6 PEZZI, CHIAVI COMBINATE A CRICCHETTO CON SNODO

BGS articolo	DESCRIZIONE
BGS 30004	METRICHE, 8-19 MM
BGS 30005	IN POLLICI 1/4" - 9/16"

CARATTERISTICHE

- misure:
 - BGS 30004: 8 - 10 - 13 - 14 - 17 - 19 mm
 - BGS 30005: 1/4" - 5/16" - 3/8" - 7/16" - 1/2" - 9/16"
- cricchetto snodato 180°
- meccanismo a cricchetto da 72 denti
- finitura cromata

CON SNODO **EXTRA CORTE**



POLIGONALE



CHIAVI COMBINATE EXTRA CORTE CRICCHETTO POLIGONALE CON SNODO SATINATE CROMATE

BGS articolo	mm	L mm	
BGS 6908	8	95	1
BGS 6909	9	95	1
BGS 6910	10	100	1
BGS 6911	11	100	1
BGS 6912	12	110	1
BGS 6913	13	115	1
BGS 6914	14	120	1
BGS 6915	15	120	1
BGS 6916	16	125	1
BGS 6917	17	130	1
BGS 6918	18	135	1
BGS 6919	19	140	1



PRO+

SUPPORTO PER CHIAVI COMBINATE

BGS articolo	DESCRIZIONE
BGS 1176	12 VANI
BGS 1177	15 VANI

CARATTERISTICHE

- dimensioni:
 - BGS 1176: 226 x 155 x 23 mm
 - BGS 1177: 297 x 180 x 28 mm
- in plastica nera
- con fori per fissaggio a muro

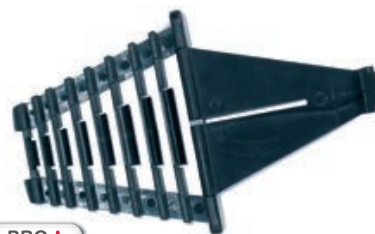

PRO+

BGS articolo	DESCRIZIONE
BGS 1175	SUPPORTO DA 8 VANI PER CHIAVI COMBINATE

CARATTERISTICHE

- in plastica nera
- per chiavi di misura fino a 20 mm
- meccanismo di chiusura
- peso 70 g



POLIGONALE

SET 12 PEZZI, CHIAVI COMBINATE A CRICCHETTO CON SNODO, 8-19 MM

BGS articolo	DESCRIZIONE
BGS 30002	SET 12 PEZZI, CHIAVI COMBINATE A CRICCHETTO CON SNODO, 8-19 MM

CARATTERISTICHE

- chiave con anello a cricchetto da 72 denti
- testa con anello a cricchetto snodato 180°
- misure: 8 - 9 - 10 - 11 - 12 - 13 - 14 - 15 - 16 - 17 - 18 - 19 mm
- finitura cromata
- in custodia
- peso 1,8 kg

EXTRA CORTE



POLIGONALE

BGS articolo	DESCRIZIONE
BGS 30003	SET 12 PEZZI, CHIAVI COMBINATE A CRICCHETTO EXTRA-CORTE CON SNODO, 8-19 MM

CARATTERISTICHE

- chiave con anello a cricchetto da 72 denti
- testa con anello a cricchetto snodato 180°
- misure: 8 - 9 - 10 - 11 - 12 - 13 - 14 - 15 - 16 - 17 - 18 - 19 mm
- chiavi extra corte (lunghezza di ciascuna chiave): 8 (89 mm), 9 (95 mm), 10 (97 mm), 11 (100 mm), 12 (102 mm), 13 (109 mm), 14 (115 mm), 15 (119 mm), 16 (123 mm), 17 (129 mm), 18 (132 mm), 19 (141 mm)
- finitura cromata
- in custodia
- peso 1,3 kg



PRO+

BGS articolo	DESCRIZIONE
BGS 6781	12 VANI
BGS 6782	8 VANI

CARATTERISTICHE

- adatto per fissaggio a muro
- dimensioni (lunghezza x larghezza x altezza):
 - BGS 6781: 280 X 130 X 37 mm
 - BGS 6782: 220 X 130 X 37 mm
- impugnatura in materiale bi-componente
- materiale: plastica
- colore: nero

CHIAVI COMBINATE A CRICCHETTO

5 CHIAVI A CRICCHETTO

CHIAVI A CRICCHETTO

NEW



POLIGONALE 1/4" 1/4"

FEIMEC articolo	DESCRIZIONE
FM 1413	SET 3 PEZZI, CHIAVI A CRICCHETTO PIEGHEVOLI

CARATTERISTICHE

- con cricchetti 72 denti
- ideale per uso in spazi ristretti
- doppio snodo da 180°
- comprende:
 - chiave a cricchetto doppio snodo 8 - 10 mm lunghezza 65 mm
 - chiave a cricchetto doppio snodo 11 - 13 mm lunghezza 75 mm
 - chiave a cricchetto doppio snodo, lunghezza 65 mm
 - portabussole quadro maschio 1/4"
 - portainseri esagono femmina 1/4"



1 CHIAVE 4 MISURE

CHIAVI COMBinate A DOPIPO CRICCHETTO POLIGONALE CON 2 MISURE IN OGNI LATO + LEVA DI INVERSIONE

FEIMEC articolo	mm	L mm	
DPW 8123	8 x 10 12 x 13	170	1
DPW 1019 NEW	10 x 13 17 x 19	210	1
DPW 1419	14 x 17 18 x 19	225	1
DPW 82	SET 2 CHIAVI IN CUSTODIA DPW 8123 + DPW 1419		1



CHIAVE A CRICCHETTO "4 IN 1"

BGST articolo	mm
BGS 30809	8 X 9 - 10 X 11
BGS 30818 NEW	10 X 12 - 14 X 17
BGS 30812	12 X 13 - 14 X 15
BGS 30816	16 X 17 - 18 X 19

CARATTERISTICHE

- chiavi a cricchetto con 4 misure per ogni chiave
- satinata cromate



PRO+ CV POLIGONALE

BGST articolo	DESCRIZIONE
BGS 1556	SET 3 PEZZI, CHIAVI A CRICCHETTO "4 IN 1"

CARATTERISTICHE

- 3 chiavi a cricchetto con 4 misure per ogni chiave
- misure: 8 x 9 - 10 x 11 mm, 12 x 13 - 14 x 15 mm, 16 x 17 - 18 x 19 mm
- reversibili
- in custodia
- peso 560 g



BGST articolo	DESCRIZIONE
BGS 6837	SET 3 PEZZI, CHIAVI A CRICCHETTO "4 IN 1", 8 X 9 - 18 X 19 MM

CARATTERISTICHE

- 3 chiavi a cricchetto con 4 misure per ogni chiave
- misure:
 - 8 x 9 - 10 x 11 mm
 - 12 x 13 - 14 x 15 mm
 - 16 x 17 - 18 x 19 mm
- reversibili
- in supporto
- peso: 680 g

XXL



PRO+ CV POLIGONALE

BGS articolo	DESCRIZIONE
BGS 1541	SET 10 PEZZI, CHIAVI A CRICCHETTO A DOPPIA TESTA SNODATA, 8-19 MM

CARATTERISTICHE

- chiavi extra-lunghe / con teste snodate
- comprende:
 - BGS 8 x 9 mm (lunghezza: 237 mm),
 - BGS 10 x 11 mm (lunghezza: 294 mm),
 - BGS 12 x 13 mm (lunghezza: 327 mm),
 - BGS 14 x 15 mm (lunghezza: 370 mm),
 - BGS 16 x 18 mm (lunghezza: 409 mm),
 - BGS 17 x 19 mm (lunghezza: 412 mm)
- 3 adattatori per bussole: 1/4" - 3/8" - 1/2"
- peso: 2,4 kg

RICAMBI

BGS articolo	DESCRIZIONE
BGS 1541-8X9	NEW 8 X 9 MM
BGS 1541-10X11	NEW 10 X 11 MM
BGS 1541-12X13	NEW 12 X 13 MM
BGS 1541-14X15	NEW 14 X 15 MM
BGS 1541-16X18	NEW 16 X 18 MM
BGS 1541-17X19	NEW 17 X 19 MM

NEW



BGS articolo

BGS articolo	DESCRIZIONE
BGS 91541	SET 10 PEZZI, CHIAVI A CRICCHETTO A DOPPIA TESTA SNODATA, 8-19 MM

CARATTERISTICHE

- chiavi extra-lunghe / con teste snodate
- forgiato a freddo
- snodate, teste flessibili regolabili a 90°
- cricchetto a dentatura fine: 72 denti
- finitura: cromata lucida
- in custodia in stoffa
- comprende:
 - chiave a cricchetto a doppia testa snodata, poligonali:
 - 8 x 9 mm, lunghezza: 245 mm
 - 10 x 11 mm, lunghezza: 280 mm
 - 12 x 13 mm, lunghezza: 340 mm
 - 14 x 15 mm, lunghezza: 380 mm
 - 16 x 18 mm, lunghezza: 410 mm
 - 17 x 19 mm, lunghezza: 415 mm
 - 3 adattatori bussole:
 - attacco 14 mm - quadro maschio 1/4"
 - attacco 14 mm - quadro maschio 3/8"
 - attacco 19 mm - quadro maschio 1/2"
 - 1 adattatore portainseriti magnetico,
 - attacco 14 mm - portainseriti esagonale 1/4"
- peso 1,9 kg



POLIGONALE TORX®

1/4" 1/4" 3/8" 1/2"

FEARTEC articolo	DESCRIZIONE
24260	SET 23 PEZZI, CHIAVI EXTRA-LUNGHE CON BUSSOLE E ADATTATORI

CARATTERISTICHE

- chiavi a cricchetto extra-lunghe da 14 e 17 mm, lunghezza 395 mm, anello+cricchetto poligonale con snodo 180°
- chiavi a bussola poligonali:
 - attacco esagonale 14 mm: 10, 11, 12, 13, 14 mm
 - attacco esagonale 17 mm: 15, 16, 17, 18, 19 mm
- chiavi a bussola poligonali lunghezza 63 mm:
 - attacco esagonale 14 mm: 14 mm
 - attacco esagonale 17 mm: 17 mm
- chiavi a bussola Torx femmina:
 - attacco esagonale 14 mm: E8, E10, E12, E14
 - attacco esagonale 17 mm: E16, E18, E20, E22, E22
- adattatore porta inserti:
 - attacco esagonale 14 mm - ○ 1/4"
- adattatori porta bussole:
 - attacco esagonale 14 mm - ■ 1/4"
 - attacco esagonale 17 mm - ■ 3/8"
 - attacco esagonale 17 mm - ■ 1/2"
- 10 OR di ricambio per chiavi att. esagonale 14 mm
- 10 OR di ricambio per chiavi att. esagonale 17 mm

RICAMBI

FEARTEC articolo	DESCRIZIONE
24260-10 DSKT	BUSSOLA POLIG. 10 MM
24260-11 DSKT	BUSSOLA POLIG. 11 MM
24260-12 DSKT	BUSSOLA POLIG. 12 MM
24260-13 DSKT	BUSSOLA POLIG. 13 MM
24260-14 DSKT	BUSSOLA POLIG. 14 MM
24260-15 DSKT	BUSSOLA POLIG. 15 MM
24260-16 DSKT	BUSSOLA POLIG. 16 MM
24260-17 DSKT	BUSSOLA POLIG. 17 MM
24260-18 DSKT	BUSSOLA POLIG. 18 MM
24260-19 DSKT	BUSSOLA POLIG. 19 MM
24260-CRICCO 14	CHIAVE A CRICCHETTO 14 MM
24260-CRICCO 17	CHIAVE A CRICCHETTO 17 MM

5 CHIAVI A CRICCHETTO

CHIAVI A CRICCHETTO



BGS articolo	DESCRIZIONE
BGS 1450	SET 5 PEZZI, CRICCHETTI, 6X8-19X22 MM

CARATTERISTICHE	
• finitura cromata	
• piatte	
• reversibili	
• comprende: 6x8 - 9x10 - 12x13 - 15x17 - 19x22 mm	
• peso 1,1 kg	

POLLICI



BGS articolo	DESCRIZIONE
BGS 1449	SET 5 PEZZI, CRICCHETTI, IN POLLICI, 1/4"-7/8"

CARATTERISTICHE	
• piatte	
• reversibili	
• misure: 1/4" x 5/16 - 3/8" x 7/16" - 1/2" x 9/16" - 5/8" x 11/16" - 3/4" x 7/8"	
• peso 1,1 kg	



BGS articolo	DESCRIZIONE
BGS 2242	SET 34 PEZZI, CHIAVE A CRICCHETTO A "S"

CARATTERISTICHE	
• comprende:	
- chiave a cricchetto a S, reversibile, un lato idoneo per bussole, l'altro per inserti, particolarmente adatta per lavorare in aree di difficile accesso	
- prolunga da 50 mm attacco quadro 1/4"	
- snodo attacco quadro 1/4"	
- adattatore portainseriti	
- bussole esagonali: 5-6-7-9-8-10-11-12-13 mm	
- inserti brugola esagonali: 3 - 4 - 5 - 6 - 8 mm	
- inserti Torx: TX15 - TX20 - TX25 - TX27 - TX30	
- inserti PH: PH1 - PH2 - PH3	
- inserti PZ PZ1 - PZ2 - PZ3	
- inserti taglio: 4,5 - 5 - 5,5 - 7 mm	
• peso 540 g	

NEW



BGS articolo	DESCRIZIONE
BGS 71016	CHIAVE A CRICCHETTO DOPPIO, CON 5 ADATTATORI, 8 - 19 MM

CARATTERISTICHE	
• con adattatori intercambiabili per chiave a cricchetto	
• cricchetto a denti fini, 72 denti	
• materiale chiave a cricchetto doppio: acciaio	
• materiale adattatori: acciaio al cromo vanadio	
• impronta poligonale	
• comprende:	
- 1 adattatore esagonale 8 mm	
- 1 adattatore esagonale 10 mm	
- 1 adattatore esagonale 12 mm	
- 1 adattatore esagonale 13 mm	
- 1 adattatore esagonale 17 mm	
- 1 chiave a cricchetto doppia 14 x 19 mm	
• peso 320 g	

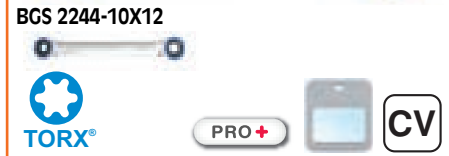

BGS articolo	DESCRIZIONE
BGS 2244	SET 4 PEZZI, CHIAVI A CRICCHETTO A DOPPIA ESTREMITA TIPO TORX

CARATTERISTICHE	
• misure: E6xE8, E10xE12, E14xE18, E20xE24	
• cricchetto 72 denti	
• peso 880 g	

RICAMBI	
BGS articolo	DESCRIZIONE
BGS 2244-10X12	CHIAVE E10 X E12

NEW



BGS articolo	DESCRIZIONE
BGS 71028	SET 4 PEZZI, CHIAVI A CRICCHETTO A DOPPIA ESTREMITA SNODATA, TIPO TORX, E6 - E24

CARATTERISTICHE	
• misure:	
- E6 x E8 (lunghezza 186 mm)	
- E10 x E12 (lunghezza 200 mm)	
- E14 x E18 (lunghezza 238 mm)	
- E20 x E24 (lunghezza 265 mm)	
• cricchetto 72 denti	
• finitura cromata satinata	
• doppio snodo	
• peso 780 g	



ADATTATORI PER CHIAVI A CRICCHETTO

FEEMEC articolo	Descrizione	
WR 143812	SET 4 PEZZI ADATTATORI PER CHIAVI A CRICCO (WR 141014 - 141063 - 141338 - 141912)	1
	 Adattatore	
WR 141014	10 mm  1/4" inserti	1
WR 145016	13 mm  5/16" inserti	1
WR 141610	13 mm  10 mm. inserti	1
WR 141063	10 mm  1/4" bussole	1
WR 141338	13 mm  3/8" bussole	1
WR 141912	19 mm  1/2" bussole	1



BGS articolo	DESCRIZIONE
BGS 8210	SET 4 PEZZI, ADATTATORI PER CHIAVI A CRICCHETTO

CARATTERISTICHE

- 3 adattatori con pulsante di sgancio rapido:
 - 1/4" quadro (per chiavi a cricchetto da 10 mm),
 - 3/8" quadro (per chiavi a cricchetto da 13 mm),
 - 1/2" quadro (per chiavi a cricchetto da 19 mm),
- 1 adattatore per inserti da 1/4" (per chiavi a cricchetto da 10 mm),
- finitura lucida
- peso 110 g



NEW





BGS articolo	DESCRIZIONE
BGS 98210	SET 4 PEZZI, ADATTATORI PER CHIAVI A CRICCHETTO

CARATTERISTICHE

- 3 adattatori con pulsante di sgancio rapido:
 - 1/4" quadro (per chiavi a cricchetto da 14 mm)
 - 3/8" quadro (per chiavi a cricchetto da 14 mm)
 - 1/2" quadro (per chiavi a cricchetto da 19 mm)
- 1 adattatore per inserti da 1/4" (per chiavi a cricchetto da 14 mm),
- finitura cromata lucida + nero opaco
- peso 130 g





CHIAVE TORX® MASCHIO ATTACCO ESAGONALE 13 MM CON SFERA IDEALE PER USO CON CHIAVI A CRICCHETTO

FEEMEC articolo		L mm	
50015	TX 15	25	1
50020	TX 20	25	1
50025	TX 25	25	1
50027	TX 27	25	1
50030	TX 30	25	1
50040	TX 40	25	1
50045	TX 45	25	1
50050	TX 50	25	1
50055	TX 55	25	1





CHIAVE XZN MASCHIO ATTACCO ESAGONALE 13 MM CON SFERA IDEALE PER USO CON CHIAVI A CRICCHETTO

FEEMEC articolo		L mm	
50404	M 4	25	1
50405	M 5	25	1
50406	M 6	25	1
50408	M 8	25	1
50410	M 10	25	1



CHIAVE ESAGONALE MASCHIO ATTACCO ESAGONALE 13 MM CON SFERA IDEALE PER USO CON CHIAVI A CRICCHETTO

FEEMEC articolo		L mm	
50204	4	25	1
50205	5	25	1
50206	6	25	1
50207	7	25	1
50208	8	25	1
50210	10	25	1

5 CHIAVI A CRICCHETTO

CHIAVI A CRICCHETTO

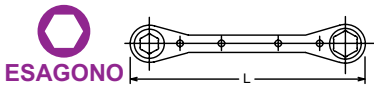

CRICCHETTO SENZA LEVA REVERSIBILE

Koken articolo	mm	L mm	Euro
102NM-6X7	6 X 7	108	1
102NM-7X8	7 X 8	108	1
102NM-8X9	8 X 9	134	1
102NM-8X10	8 X 10	134	1
102NM-10X11	10 X 11	140	1
102NM-10X12	10 X 12	140	1
102NM-11X13	11 X 13	145	1
102NM-12X13	12 X 13	145	1
102NM-12X14	12 X 14	145	1

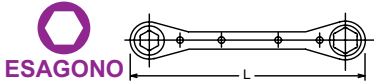

CRICCHETTO SENZA LEVA REVERSIBILE

Koken articolo	pollici	L mm	Euro
102NA-7/32 X 1/4	7/32" X 1/4"	108	1
102NA-1/4 X 9/32	1/4" X 9/32"	108	1
102NA-1/4 X 5/16	1/4" X 5/16"	134	1
102NA-5/16 X 11/32	5/16" X 11/32"	134	1
102NA-5/16 X 3/8	5/16" X 3/8"	140	1
102NA-3/8 X 7/16	3/8" X 7/16"	140	1
102NA-7/16 X 1/2	7/16" X 1/2"	145	1
102NA-1/2 X 9/16	1/2" X 9/16"	145	1

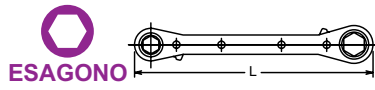

CRICCHETTO REVERSIBILE CON LEVA

Koken articolo	mm	L mm	Euro
102KM-6X7	6 X 7	108	1
102KM-7X8	7 X 8	108	1
102KM-8X9	8 X 9	134	1
102KM-8X10	8 X 10	134	1
102KM-10X11	10 X 11	141	1
102KM-10X12	10 X 12	141	1
102KM-12X13	12 X 13	146	1
102KM-12X14	12 X 14	146	1
102KM-13X17	13 X 17	200	1
102KM-14X17	14 X 17	200	1

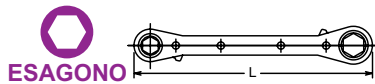

CRICCHETTO REVERSIBILE CON LEVA

Koken articolo	pollici	L mm	Euro
102KA-7/32X1/4	7/32" X 1/4"	108	1
102KA-1/4X5/16	1/4" X 5/16"	108	1
102KA-5/16X11/32	5/16" X 11/32"	134	1
102KA-3/8X7/16	3/8" X 7/16"	141	1
102KA-1/2X9/16	1/2" X 9/16"	146	1



**CRICCHETTO REVERSIBILE 2 IN 1
4 MISURE - 2 IN OGNI LATO**

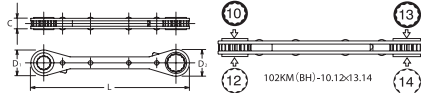

Koken articolo	mm	mm	L mm	Euro
102KM.BH-5,5-6X7-8	5,5X6	7X8	108	1
102KM.BH-8-10X12-13	8X10	12X13	141	1
102KM.BH-9-10X11-12	9X10	11X12	141	1
102KM.BH-10-12X13-14	10X12	13X14	146	1
102KM.BH-13-14X15-17	13X14	15X17	200	1

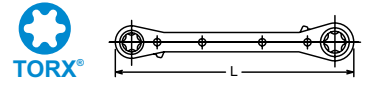

CRICCHETTO REVERSIBILE CON LEVA

Koken articolo	mm	L mm	Euro
102KT-E4XE6	E 4 X E 6	108	1
102KT-E6XE8	E 6 X E 8	108	1
102KT-E10XE12	E10 X E12	134	1

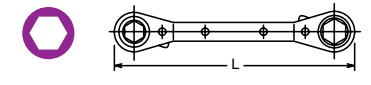

CRICCHETTO REVERSIBILE PIEGATO

Koken articolo	mm	L mm	Euro
103KM-6X7	6 X 7	103	1
103KM-7X8	7 X 8	103	1
103KM-8X9	8 X 9	128	1
103KM-8X10	8 X 10	128	1
103KM-10X11	10 X 11	134	1
103KM-10X12	10 X 12	134	1
103KM-12X13	12 X 13	139	1
103KM-12X14	12 X 14	139	1

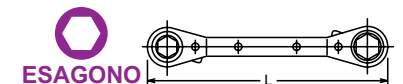

CRICCHETTO REVERSIBILE PIEGATO

Koken articolo	pollici	L mm	Euro
103KA-7/32 X 1/4	7/32" X 1/4"	108	1
103KA-1/4 X 5/16	1/4" X 5/16"	108	1
103KA-5/16 X 11/32	5/16" X 11/32"	134	1
103KA-5/16 X 3/8	5/16" X 3/8"	134	1
103KA-3/8 X 7/16	3/8" X 7/16"	140	1
103KA-7/16 X 1/2	7/16" X 1/2"	145	1
103KA-1/2 X 9/16	1/2" X 9/16"	145	1



POLLICI **JAPAN**



POLIGONALE



CRICCHETTO REVERSIBILE PIEGATO POLIGONALE

Koken articolo	pollici	L mm		Euro
103KA.BH-1/4X5/16	1/4" X 5/16"	108	1	
103KA.BH-3/8X7/16	3/8" X 7/16"	140	1	
103KA.BH-1/2X9/16	1/2" X 9/16"	145	1	

JAPAN



ESAGONO



CRICCHETTO SNODATO PORTA BUSSOLE CON ATTACCO ESAGONALE 10 mm

Koken articolo	DESCRIZIONE	Euro
1206 K	SET 3 PEZZI	

CONTENUTO

BUSSOLE	
	12, 14 mm

JAPAN



Koken articolo	DESCRIZIONE	Euro
1203	Cassetta metallica 7 Pz. 130 x 65 x h 20 mm	

CARATTERISTICHE

BUSSOLE		
	150-10H	5, 6, 7, 8, 9, 10

ACCESSORI 145KM-10H

JAPAN



TORX®



CRICCHETTO REVERSIBILE PIEGATO

Koken articolo		L mm		Euro
103KT-E4XE6	E 4 X E 6	104	1	
103KT-E6XE8	E 6 X E 8	104	1	
103KT-E10XE12	E 10 X E 12	128	1	
103KT-E14XE16	E 14 X E 16	139	1	



JAPAN **NEW**



POLIGONALE



CHIAVI A BUSSOLA POLIGONALI A MANO BOCCA ESAGONALE EXTRA CORTE PER CRICCHETTI 14 MM

Koken articolo	mm	D mm	L mm		Euro
150-14H-10	10	16,0	17	1	
150-14H-12	12	17,3	18	1	
150-14H-14	14	19,2	21	1	

JAPAN



ESAGONO

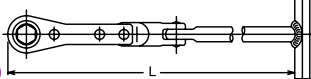

CRICCHETTO DOPPIO SNODO

Koken articolo	mm	L mm		Euro
154M-8	8	249	1	
154M-10	10	297	1	
154M-12	12	300	1	
154M-13	13	301	1	
154M-14	14	301	1	

JAPAN



ESAGONO



CRICCHETTO REVERSIBILE

Koken articolo	mm	L mm		Euro
145KM-H-10	10	125	1	

JAPAN



LEVA A CRICCO CON ACCESSORI

Koken articolo	DESCRIZIONE	Euro
1210 EK	Kit 11 Pz. in contenitore plastico	

CARATTERISTICHE

BUSSOLE		
	179B-12H	10-12-13 mm 

INSERTI		
	XZN 179B-12H	M8, M10, M12
	TORX® 179B-12H	T40, T45, T50
	ESAGONO 179B-12H	8 mm

JAPAN



ESAGONO

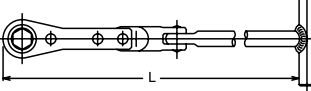

CRICCHETTO DOPPIO SNODO E BLOCCAGGIO

Koken articolo	mm	L mm		Euro
154ML-10	10	297	1	
154ML-12	12	300	1	

JAPAN



ESAGONO



CHIAVI A BUSSOLA A MANO BOCCA ESAGONALE EXTRA CORTE PER CRICCHETTI 10 MM

Koken articolo	mm	D mm	L mm		Euro
150-10H-5	5	12	11	1	
150-10H-6	6	12	12,5	1	
150-10H-7	7	12	14	1	
150-10H-8	8	12	15,5	1	
150-10H-9	9	13	16	1	
150-10H-10	10	14,3	17	1	
150-10H-12	12	17,4	19,5	1	

Per Audi, BMW, Citroen, Fiat, Ford, Lancia, Nissan, Smart, Mercedes, Opel, Peugeot, Renault, Rover, Seat, Skoda, Volkswagen.

5 CHIAVI A CRICCHETTO

CHIAVI A CRICCHETTO

JAPAN



1/4" 3/8"

CRICCHETTO DOPIO

Koken articolo	1/4" x 3/8"	L mm	Euro
137-1/4x3/8		141	1

JAPAN



PHILLIPS®

1/4"

INSERTO PER CRICCHETTO

Koken articolo	PH	L mm	Euro
101P-1	PH 1	20,5	1
101P-2	PH 2	20,5	1
101P-3	PH 3	20,5	1

JAPAN



TORX®

1/4"

INSERTO CON SFERA PER CRICCHETTO

Koken articolo	Torx	L mm	Euro
101-T9	TX 9	25	1
101-T10	TX 10	25	1
101-T15	TX 15	25	1
101-T20	TX 20	25	1
101-T25	TX 25	25	1
101-T27	TX 27	25	1
101-T30	TX 30	25	1

JAPAN



1/4" 1/4"

CRICCHETTO DOPIO PER INSERTI CON SFERA ART. 101

Koken articolo	1/4" x 1/4"	L mm	Euro
138-1/4x1/4		141	1

JAPAN



TAGLIO

1/4"

INSERTO CON SFERA PER CRICCHETTO

Koken articolo	mm	L mm	Euro
101S-1,0x7	1.0 x 7	15	1
101S-1,2x7	1.0 x 7	15	1

JAPAN



TORX® CON FORO

1/4"

INSERTO CON SFERA PER CRICCHETTO

Koken articolo	Torx	L mm	Euro
101-T10H	TH 10	25	1
101-T15H	TH 15	25	1
101-T20H	TH 20	25	1
101-T25H	TH 25	25	1
101-T27H	TH 27	25	1
101-T30H	TH 30	25	1

JAPAN



1/4"

CRICCHETTO

Koken articolo	1/4"	L mm	Euro
139-1/4		125	1

JAPAN



ESAGONO

1/4"

INSERTO CON SFERA PER CRICCHETTO

Koken articolo	mm	L mm	Euro
101H-3	3	20,5	1
101H-4	4	20,5	1
101H-5	5	20,5	1
101H-6	6	20,5	1
101H-7	7	20,5	1
101H-8	8	20,5	1

JAPAN



ESAGONO

5/16"

INSERTO CON SFERA PER CRICCHETTO

Koken articolo	mm	L mm	Euro
128H-3	3	32	1
128H-4	4	32	1
128H-5	5	32	1
128H-6	6	32	1
128H-8	8	32	1

JAPAN



POLIGONALE

POLLICI

CRICCHETTO POLIGONALE PER INSERTI CON SFERA ART. 101-128

Koken articolo	pollici	L mm	Euro
R810-1/4x5/16	1/4" x 5/16"	108	1
R810-3/8x7/16	3/8" x 7/16"	140	1
R810-1/2x9/16	1/2" x 9/16"	145	1

JAPAN



ESAGONO

1/4"

INSERTO CON SFERA PER CRICCHETTO

Koken articolo	mm	L mm	Euro
101B-3	3	25	1
101B-4	4	25	1
101B-5	5	25	1
101B-6	6	25	1



JAPAN



TORX®

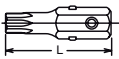

5/16"

INSERTO PER CRICCHETTO

Koken articolo	Icona	L mm	Box	Euro
128-T10	TX 10	32	1	
128-T15	TX 15	32	1	
128-T20	TX 20	32	1	
128-T25	TX 25	32	1	
128-T27	TX 27	32	1	
128-T30	TX 30	32	1	

JAPAN



1/4"



5/16"

ADATTATORE CON SFERA

Koken articolo	Icona	L mm	Box	Euro
101A	1/4"	20	1	

JAPAN



Koken articolo	DESCRIZIONE	Euro
1202	Cassetta metallica 15 Pz. 190 x 60 x h 30 mm	

CARATTERISTICHE

	101P	1, 2, 3
	101S	1x7
	101B	3, 4, 5, 6
	101T	8
	138	CRICCHETTO

JAPAN



Koken articolo	DESCRIZIONE	Euro
2254M	Cassetta metallica 12 Pz. 160 x 100 x h 28 mm	

CARATTERISTICHE

	101P	1, 2, 3
	101S	1x7, 1,2x7
	101H	3, 4, 5

ACCESSORI

102NA-1/4x5/16	
2769F	
101A	
2137	

TOP

POLLICI

3/16"
1/4"

QUADRO

5/16"
3/8"

QUADRO

QUADRO QUADRO



FEFMEC articolo	DESCRIZIONE
RVKT 3153	CHIAVE QUADRA CON DOPPIO CRICCHETTO, IN POLLICI, 3/16" X 1/4"-5/16" X 3/8"

CARATTERISTICHE

- piatte
- reversibili
- misure: 3/16" X 1/4" - 5/16" X 3/8"



PRO+ CV

CHIAVE PER RACCORDI ESAGONALE

BGS articolo	mm
BGS 1750	10 X 11
BGS 1751	12 X 13
BGS 1752	15 X 17

CARATTERISTICHE

- finitura satinata cromata
- esagonali
- angolo 15°



PRO+ CV

BGS articolo	DESCRIZIONE
BGS 1755	SET 2 PEZZI, CHIAVI PER RACCORDI ESAGONALI, 10X11 - 12X13 MM

CARATTERISTICHE

- finitura satinata cromata
- esagonali
- comprende:
 - art. BGS 1750: 10 x 11 mm
 - art. BGS 1751: 12 x 13 mm
- peso 180 g



BGS 1745-8x9

PRO+ CV

BGS articolo	DESCRIZIONE
BGS 1745	SET 6 PEZZI, CHIAVI PER RACCORDI ESAGONALE, 8X9 - 18X19 MM

CARATTERISTICHE

- forgiate a freddo
- per viti su linee freni
- misure: 8x9, 10x11, 12x13, 14x15, 16x17, 18x19 mm
- finitura cromata satinata
- peso 740 g

RICAMBI

BGS articolo	DESCRIZIONE
BGS 1745-8X9	CHIAVE 8 X 9 MM

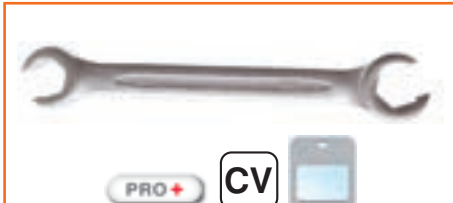

PRO+ CV

CHIAVE PER RACCORDI APERTE

BGS articolo	mm	
BGS 1761-8X10	8 x 10	1
BGS 1761-9X11	9 x 11	1
BGS 1761-12X13	12 x 13	1
BGS 1761-14X15	14 x 15	1
BGS 1761-16X18	16 x 18	1
BGS 1761-17X19	17 x 19	1
BGS 1761-17X22 NEW	17 x 22	1
BGS 1761-19X22	19 x 22	1
BGS 1761-24X27	24 x 27	1
BGS 1761-30X32	30 x 32	1

CARATTERISTICHE

- finitura satinata cromata
- articoli BGS 1761-17x22, BGS 1761-24x27 e BGS 1761-30x32 poligonali



PRO+ CV

BGS articolo	DESCRIZIONE
BGS 1761	SET 6 PEZZI, CHIAVI PER RACCORDI ESAGONALI, 8X10 - 17X19 MM

CARATTERISTICHE

- finitura satinata cromata
- misure: 8 x 10 mm, 9 x 11 mm, 12 x 13 mm, 14 x 15 mm 16 x 18 mm, 17 x 19 mm
- In custodia
- peso 940 g

POLLICI



PRO+ CV

BGS articolo	DESCRIZIONE
BGS 1782	SET 4 PEZZI, CHIAVI PER RACCORDI ESAGONALI, SFALSATE DI 15°, MISURE IN POLLICI, 5/16" - 3/4"

CARATTERISTICHE

- finitura cromata satinata
- misure: 5/16"x3/8", 7/16"x1/2", 9/16"x5/8", 11/16"x3/4"
- forgiate a freddo
- in custodia
- peso 520 g



CHIAVE SNODATA ESAGONALE E POLIGONALE PER RACCORDI TUBI CHROM-VANADIUM - CROMATA HRC 44/48

articolo	mm	L mm	
CRT-8	8	129	1
CRT-9	9	129	1
CRT-10	10	129	1
CRT-11	11	148	1
CRT-12	12	148	1
CRT-13	13	175	1
CRT-14	14	175	1
CRT-15	15	175	1
CRT-17	17	190	1
CRT-19	19	190	1
CRT-21	21	190	1
CRT-22	22	190	1
CRT-24	24	190	1
CRT-27	27	200	1



CHIAVE SNODATA ESAGONALE E POLIGONALE PER RACCORDI TUBI CHROM-VANADIUM - CROMATA HRC 44/48

articolo	pollici	L mm	
CRT-5/16"	5/16"	129	1
CRT-3/8"	3/8"	129	1
CRT-7/16"	7/16"	148	1
CRT-1/2"	1/2"	148	1
CRT-9/16"	9/16"	175	1
CRT-5/8"	5/8"	175	1
CRT-11/16"	11/16"	190	1
CRT-3/4"	3/4"	190	1
CRT-13/16"	13/16"	190	1
CRT-7/8"	7/8"	190	1
CRT-15/16"	15/16"	190	1



CHIAVI DOPPIO SNODO PER FRENI, MISURE METRICHE

articolo	DESCRIZIONE
BGS 30412	CHIAVE DOPPIO SNODO, 9 X 11 MM
BGS 30413	CHIAVE DOPPIO SNODO, 10 X 12 MM

CARATTERISTICHE

- con estremità snodate - regolabili in continuo



SERIE 7 PEZZI CHIAVE SNODATA ESAGONALE - POLIGONALE

articolo	Descrizione	
CRT-817	SET 7 PEZZI 8-10-11-12 13-14-17	1



SERIE 7 PEZZI CHIAVE SNODATA ESAGONALE - POLIGONALE IN POLLICI

articolo	Descrizione	
CRT-534	SET 7 PEZZI 5/16"-3/8" - 7/16"- 1/2"-9/16"-5/8"-3/4"	1



articolo	DESCRIZIONE
BGS 9441	CHIAVE PER RACCORDI TUBI, 8 IN 1, 8-19 MM

CARATTERISTICHE

- per raccordi tubi
- impronta esagonale, aperta
- misure: 8 - 10 - 11 - 12 - 13 - 14 - 17 - 19 mm
- peso 540 g

5 CHIAVI PER RACCORDI TUBI



NEW



BGS articolo	DESCRIZIONE
BGS 6895	SET 5 PEZZI, CHIAVI DOPPIO SNODO PER LINEE TUBI, CON TESTE INTERCAMBIABILI, ATT. 3/8", 11-17 MM

CARATTERISTICHE

- design compatto consente l'utilizzo in spazi ristretti
- per allentare e serrare i collegamenti dei tubi
- doppio snodo a 30°
- 5 teste intercambiabili misure: 11 - 13 - 14 - 15 - 17 mm
- impronta: poligonale scanalato
- attacco quadro femmina 3/8"
- coppia max: 30 Nm
- materiale: acciaio al carbonio
- peso: 450 g



BGS articolo	DESCRIZIONE
BGS 30836	SET 5 PEZZI, CHIAVI COMBinate A CRICCHETTO PER RACCORDI TUBI, 8-12 MM

CARATTERISTICHE

- misure: 8 - 9 - 10 - 11 - 12 mm
- cricchetto 72 denti
- in custodia
- finitura satinata cromata
- peso 590 g

RICAMBI

BGS articolo	DESCRIZIONE
BGS 30838	8 MM
BGS 30839	9 MM
BGS 30840	10 MM
BGS 30841	11 MM
BGS 30842	12 MM
TSC 13	13 MM



NEW



BGS articolo	DESCRIZIONE
BGS 30849	SET 9 PEZZI, CHIAVI COMBinate A CRICCHETTO PER RACCORDI TUBI, 8 - 17 MM

CARATTERISTICHE

- misure: 8 - 9 - 10 - 11 - 12 - 13 - 14 - 15 - 17 mm
- cricchetto 72 denti
- in custodia
- finitura satinata cromata
- peso 1,7 g

RICAMBI

BGS articolo	DESCRIZIONE
BGS 30838	8 MM
BGS 30839	9 MM
BGS 30840	10 MM
BGS 30841	11 MM
BGS 30842	12 MM
TSC 13	13 MM



NEW



BGS articolo	DESCRIZIONE
BGS 6931	SET 6 PEZZI, CHIAVI SNODATE PER RACCORDI TUBI, ATTACCO 1/2"

CARATTERISTICHE

- adatto per tubi del carburante, tubi idraulici, tubi per il condizionamento dell'aria, ecc.
- teste flessibili fino a 220°
- misure: 12 - 14 - 16 - 16 - 17 - 18 - 19 mm
- attacco quadro: 1/2"
- lunghezza: da 113 a 128 mm
- peso 2,5 kg





PRO+ **CV** **POLIGONALE**
CHIAVE A CRICCHETTO PER RACCORDI TUBI

BGS articolo	mm
BGS 30828	8
BGS 30829	9
BGS 30830	10
BGS 30831	11
BGS 30832	12
BGS 30835	15

CARATTERISTICHE

- cromo vanadio
- per uso su tubi
- poligonali



PRO+ **CV** **1/6**

BGS articolo	DESCRIZIONE
BGS 30833	1/6 MODULO PER CARRELLO, SET 4 PEZZI, CHIAVI A CRICCHETTO PER RACCORDI TUBI

CARATTERISTICHE

- comprende:
 - 8 mm, BGS 30828
 - 10 mm, BGS 30830
 - 11 mm, BGS 30831
 - 12 mm, BGS 30832
- peso 350 g

RICAMBI

BGS articolo	DESCRIZIONE
BGS 30833-1	MODULO VUOTO

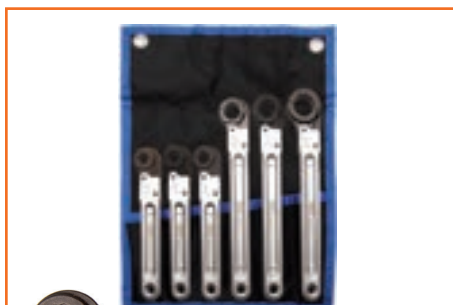

PRO+

BGS articolo	DESCRIZIONE
BGS 8665	SET 6 PEZZI, CHIAVI A CRICCHETTO PER RACCORDI TUBI, 10-22 MM

CARATTERISTICHE

- per viti poste sui tubi, ad es., linee freno, servosterzo, tubi radiatore olio, ecc...
- funzione cricchetto grazie al movimento su un unico lato della testa della chiave
- poligonali, forma dritta
- misure: 10 - 11 - 13 - 17 - 19 - 22 mm
- materiale:
 - ganasce realizzate in acciaio al cromo molibdeno
 - impugnatura realizzata in acciaio temprato cromato
- peso 1,0 kg



PRO+ **CV**
CHIAVI PER RACCORDI TUBI APERTE A CRICCHETTO

BGS articolo	mm
FM 8665-11	11
FM 8665-13	13
FM 8665-17	17
FM 8665-19	19
FM 8665-22	22
BGS 8665-24	24
BGS 8665-27	27
BGS 8665-30	30
BGS 8665-32	32

CARATTERISTICHE

- per viti poste sui tubi
- materiale:
 - ganasce realizzate in acciaio al cromo molibdeno
 - impugnatura realizzata in acciaio S45C
- poligonali



CON SNODO
CV **PRO+**

BGS articolo	DESCRIZIONE
BGS 1722	CHIAVE DOPPIO SNODO PER LINEE FRENI E TUBI CON CRICCHETTO, 10 X 11 MM

CARATTERISTICHE

- misure: 10 x 11 mm (lunghezza 160 mm),
- estremità ad anello con cricchetto
- entrambi i lati con estremità snodata ad anello
- anelli apribili per inserimento su tubi
- una molla interna garantisce la chiusura dell'anello attorno al dado
- maggiore è la pressione esercitata nel senso di avvitarlo, maggiore è la stretta della testa attorno al dado, prevenendo così lo scivolamento del dado stesso
- la chiave fa presa lungo il lato del dado, quindi funziona anche con dadi dagli angoli danneggiati



POLIGONALE

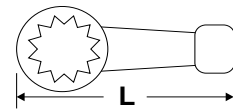

CHIAVI POLIGONALI BRUNITE A PERCUSSIONE

FEIMEC articolo	mm	L mm	
FSM 16	16	140	1
FSM 17	17	140	1
FSM 18	18	140	1
FSM 19	19	140	1
FSM 20	20	140	1
FSM 21	21	140	1
FSM 22	22	185	1
FSM 23	23	185	1
FSM 24	24	185	1
FSM 25	25	185	1
FSM 26	26	185	1
FSM 27	27	185	1
FSM 30	30	190	1
FSM 32	32	190	1
FSM 33	33	190	1
FSM 34	34	190	1
FSM 35	35	190	1
FSM 36	36	190	1
FSM 38	38	215	1
FSM 40	40	215	1
FSM 41	41	215	1
FSM 42	42	240	1
FSM 44	44	240	1
FSM 45	45	240	1

FEIMEC articolo	mm	L mm	
FSM 46	46	240	1
FSM 48	48	240	1
FSM 50	50	240	1
FSM 52	52	270	1
FSM 54	54	270	1
FSM 55	55	270	1
FSM 56	56	270	1
FSM 57	57	270	1
FSM 58	58	270	1
FSM 59	59	270	1
FSM 60	60	270	1
FSM 61	61	300	1
FSM 62	62	300	1
FSM 63	63	300	1
FSM 65	65	300	1
FSM 70	70	330	1
FSM 71	71	330	1
FSM 75	75	330	1
FSM 77	77	330	1
FSM 80	80	360	1
FSM 85	85	360	1
FSM 90	90	390	1
FSM 95	95	390	1
FSM 100	100	420	1

FEIMEC articolo	mm	L mm	
FSM 105	105	420	1
FSM 110	110	450	1
FSM 115	115	450	1
FSM 120	120	475	1
FSM 125	125	475	1
FSM 130	130	530	1
FSM 135	135	530	1
FSM 140	140	530	1
FSM 145	145	580	1
FSM 150	150	580	1
FSM 155	155	580	1
FSM 160	160	580	1
FSM 165	165	650	1
FSM 170	170	650	1
FSM 175	175	650	1
FSM 180	180	650	1
FSM 185	185	700	1
FSM 190	190	700	1
FSM 195	195	700	1
FSM 200	200	700	1
FSM 210	210	750	1
FSM 215	215	750	1
FSM 220	220	750	1

POLLICI



POLIGONALE

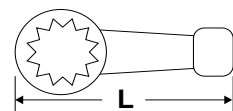

CHIAVI POLIGONALI BRUNITE A PERCUSSIONE IN POLLICI

FEIMEC articolo	pollici	L mm	
FSA 5/8"	5/8"	140	1
FSA 11/16"	11/16"	140	1
FSA 3/4"	3/4"	140	1
FSA 13/16"	13/16"	140	1
FSA 7/8"	7/8"	185	1
FSA 15/16"	15/16"	185	1
FSA 1"	1"	185	1
FSA 1-1/16"	1-1/16"	185	1
FSA 1-1/8"	1-1/8"	190	1
FSA 1-3/16"	1-3/16"	190	1
FSA 1-1/4"	1-1/4"	190	1
FSA 1-5/16"	1-5/16"	190	1
FSA 1-3/8"	1-3/8"	190	1
FSA 1-7/16"	1-7/16"	215	1
FSA 1-1/2"	1-1/2"	215	1
FSA 1-9/16"	1-9/16"	215	1
FSA 1-5/8"	1-5/8"	215	1
FSA 1-11/16"	1-11/16"	240	1
FSA 1-3/4"	1-3/4"	240	1

FEIMEC articolo	pollici	L mm	
FSA 1-13/16"	1-13/16"	240	1
FSA 1-7/8"	1-7/8"	240	1
FSA 1-15/16"	1-15/16"	240	1
FSA 2"	2"	270	1
FSA 2-1/16"	2-1/16"	270	1
FSA 2-1/8"	2-1/8"	270	1
FSA 2-3/16"	2-3/16"	270	1
FSA 2-1/4"	2-1/4"	270	1
FSA 2-5/16"	2-5/16"	270	1
FSA 2-3/8"	2-3/8"	300	1
FSA 2-7/16"	2-7/16"	300	1
FSA 2-1/2"	2-1/2"	300	1
FSA 2-9/16"	2-9/16"	300	1
FSA 2-5/8"	2-5/8"	300	1
FSA 2-11/16"	2-11/16"	300	1
FSA 2-3/4"	2-3/4"	330	1
FSA 2-13/16"	2-13/16"	330	1
FSA 2-7/8"	2-7/8"	330	1
FSA 2-15/16"	2-15/16"	330	1

FEIMEC articolo	pollici	L mm	
FSA 3"	3"	330	1
FSA 3-1/16"	3-1/16"	330	1
FSA 3-1/8"	3-1/8"	360	1
FSA 3-3/16"	3-3/16"	360	1
FSA 3-1/4"	3-1/4"	360	1
FSA 3-5/16"	3-5/16"	360	1
FSA 3-3/8"	3-3/8"	390	1
FSA 3-1/2"	3-1/2"	390	1
FSA 3-5/8"	3-5/8"	390	1
FSA 3-3/4"	3-3/4"	390	1
FSA 3-13/16"	3-13/16"	390	1
FSA 3-7/8"	3-7/8"	420	1
FSA 4"	4"	420	1
FSA 4-1/8"	4-1/8"	420	1
FSA 4-1/4"	4-1/4"	450	1
FSA 4-1/2"	4-1/2"	450	1
FSA 4-5/8"	4-5/8"	450	1
FSA 5"	5"	475	1

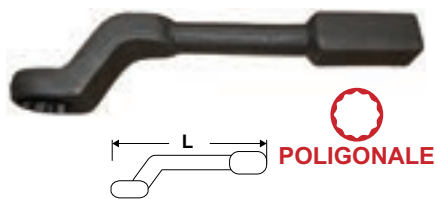

CHIAVI POLIGONALI BRUNITE A PERCUSSIONE CURVE

FE#MEC articolo	mm	L mm	
OSWM-24	24	300	1
OSWM-27	27	300	1
OSWM-30	30	300	1
OSWM-32	32	300	1
OSWM-36	36	300	1
OSWM-38	38	315	1
OSWM-40	40	315	1
OSWM-41	41	315	1
OSWM-46	46	315	1
OSWM-50	50	380	1
OSWM-55	55	380	1
OSWM-60	60	400	1
OSWM-65	65	400	1
OSWM-70	70	400	1
OSWM-75	75	400	1
OSWM-80	80	450	1
OSWM-85	85	450	1
OSWM-90	90	450	1
OSWM-95	95	450	1
OSWM-100	100	500	1
OSWM-105	105	500	1
OSWM-110	110	500	1
OSWM-115	115	500	1

POLLICI

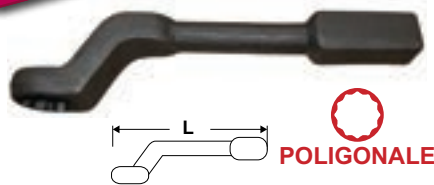

CHIAVI POLIGONALI BRUNITE A PERCUSSIONE CURVE

FE#MEC articolo	pollici	L mm	
OSWA-15/16"	15/16"	300	1
OSWA-1"	1"	300	1
OSWA-1-1/8"	1-1/8"	300	1
OSWA-1-1/4"	1-1/4"	300	1
OSWA-1-5/16"	1-5/16"	300	1
OSWA-1-3/8"	1-3/8"	300	1
OSWA-1-7/16"	1-7/16"	300	1
OSWA-1-1/2"	1-1/2"	315	1
OSWA-1-9/16"	1-9/16"	315	1
OSWA-1-5/8"	1-5/8"	315	1
OSWA-1-11/16"	1-11/16"	315	1
OSWA-1-3/4"	1-3/4"	315	1
OSWA-1-13/16"	1-13/16"	315	1
OSWA-1-7/8"	1-7/8"	380	1
OSWA-1-15/16"	1-15/16"	380	1
OSWA-2"	2"	380	1
OSWA-2-1/16"	2-1/16"	380	1
OSWA-2-1/8"	2-1/8"	380	1
OSWA-2-3/16"	2-3/16"	380	1
OSWA-2-1/4"	2-1/4"	405	1
OSWA-2-3/4"	2-3/4"	406	1
OSWA-2-7/8"	2-7/8"	406	1

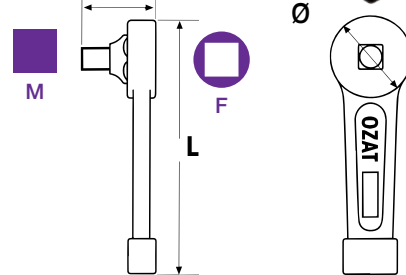

F	M
1/2"	1/2"
1/2"	3/4"
3/4"	3/4"
1"	1"
1"-1/2"	1"-1/2"

CHIAVE A PERCUSSIONE DOPPIO QUADRO MASCHIO 1" - FEMMINA 1"

FE#MEC articolo	F	M	H mm	Ø mm	L mm
FSP 0808	1/2"	1/2"	40	60	190
FSP 0812	1/2"	3/4"	60	66	215
FSP 1212	3/4"	3/4"	60	66	215
FSP 1616	1"	1"	76	86	270
FSP 2424	1"-1/2"	1"-1/2"	100	102	300

CARATTERISTICHE

- con scanalatura e foro per spina nel quadro maschio
- per bussole impact

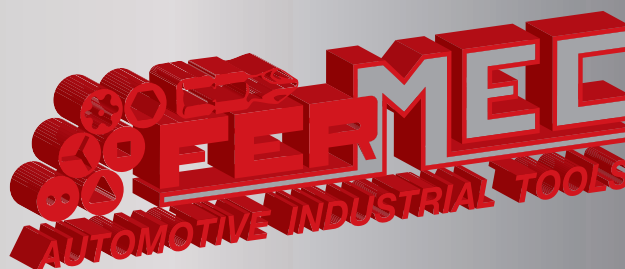





BSG articolo	mm	L mm
BSG 35230	30	190
BSG 35232	32	190
BSG 35236	36	208
BSG 35241	41	230
BSG 35246	46	250
BSG 35250	50	260
BSG 35255	55	270
BSG 35260	60	305
BSG 35265	65	305
BSG 35270	70	335
BSG 35275	75	335
BSG 35280	80	380
BSG 35285	85	380
BSG 35290	90	390
BSG 35295	95	390

CARATTERISTICHE

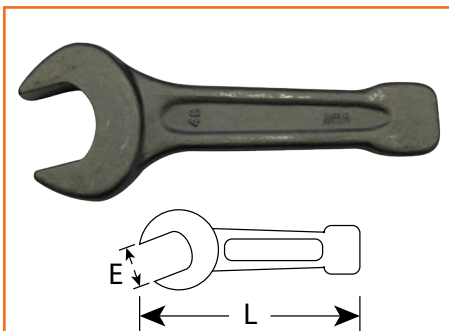
- modello pesante
- forgiate a caldo
- conformi DIN 133
- acciaio al Cromo Vanadio
- finitura nera



CHIAVI A FORCHETTA A PERCUSSIONE

FEFMEC articolo	E mm	L mm	
BFM 24	24	180	1
BFM 27	27	180	1
BFM 30	30	190	1
BFM 32	32	190	1
BFM 36	36	215	1
BFM 41	41	235	1
BFM 46	46	255	1
BFM 50	50	275	1
BFM 55	55	300	1
BFM 60	60	320	1
BFM 65	65	340	1
BFM 70	70	375	1
BFM 75	75	375	1
BFM 80	80	400	1
BFM 85	85	400	1
BFM 90	90	445	1
BFM 95	95	445	1
BFM 100	100	485	1

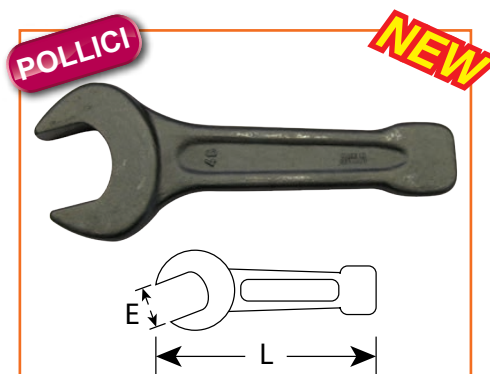

CHIAVI A FORCHETTA A PERCUSSIONE IN POLLICI

FEFMEC articolo	E mm	L mm	
BFA 7/8"	7/8	135	1
BFA 1"	1	175	1
BFA 1-1/16"	1-1/16	180	1
BFA 1-1/8"	1-1/8	180	1
BFA 1-3/16"	1-3/16	190	1
BFA 1-1/4"	1-1/4	190	1
BFA 1-5/16"	1-5/16	190	1
BFA 1-3/8"	1-3/8	215	1
BFA 1-7/16"	1-7/16	255	1
BFA 1-1/2"	1-1/2	209	1
BFA 1-9/16"	1-9/16	230	1
BFA 1-5/8"	1-5/8	230	1
BFA 1-11/16"	1-11/16	230	1
BFA 1-3/4"	1-3/4	250	1
BFA 1-13/16"	1-13/16	250	1
BFA 1-7/8"	1-7/8	250	1
BFA 1-15/16"	1-15/16	270	1
BFA 2"	2	270	1
BFA 2-1/16"	2-1/16	270	1
BFA 2-3/16"	2-3/16	300	1
BFA 2-1/4"	2-1/4	300	1
BFA 2-5/16"	2-5/16	320	1
BFA 2-3/8"	2-3/8	315	1
BFA 2-7/16"	2-7/16	315	1
BFA 2-1/2"	2-1/2	342	1
BFA 2-9/16"	2-9/16	338	1
BFA 2-5/8"	2-5/8	335	1
BFA 2-11/16"	2-11/16	335	1
BFA 2-3/4"	2-3/4	365	1
BFA 2-13/16"	2-13/16	375	1
BFA 2-7/8"	2-7/8	365	1
BFA 2-15/16"	2-15/16	360	1
BFA 3"	3	390	1



PRO+

CHIAVI A PERCUSSIONE ESAGONALI

BSG articolo	mm	L mm
BGS 35348	18 MM	214
BGS 35342	22 MM	214
BGS 35344	24 MM	214
BGS 35356	26 MM	214
BGS 35357	27 MM	214
BGS 35360	30 MM	214

CARATTERISTICHE

- per viti su connessioni a vite pinza freno da assali anteriori e posteriori di veicoli commerciali
- con quadro di manovra 3/4"
- è possibile l'uso utilizzato con una chiave dinamometrica secondo le specifiche del produttore



PRO+

CHIAVI A PERCUSSIONE TORX

BSG articolo			L mm
BGS 35318	MAN	E 18	215
BGS 35320	MAN	E 20	215
BGS 35324	MAN & MERCEDES-BENZ	E 24	215

CARATTERISTICHE

- chiavi a percussione Torx
- con quadro di manovra 3/4"
- per viti Torx su connessioni a vite pinza freno da assali anteriori e posteriori di veicoli commerciali
- l'uso della chiave per l'installazione e la rimozione delle connessioni a vite della pinza del freno consente di non dovere effettuare lo smontaggio della leva del tirante dello sterzo
- è possibile l'uso utilizzato con una chiave dinamometrica secondo le specifiche del produttore
- per:
 - BGS 35318: MAN: TGL TGM
 - BGS 35320: MAN: TGL TGM
 - BGS 35324:
 - MAN TGA TGS TCX
 - MERCEDES-BENZ Atego 970-976 - connessioni con vite di sospensioni idrauliche / pinze freni su asse posteriore



PRO+

CHIAVI A PERCUSSIONE POLIGONALI

BSG articolo		mm	L mm
BGS 35339	NEW	19 MM	214
BGS 35334		24 MM	215
BGS 35336		26 MM	215
BGS 35330	NEW	30 MM	220

CARATTERISTICHE

- per viti su connessioni a vite pinza freno da assali anteriori e posteriori di veicoli commerciali
- con quadro di manovra 3/4"
- è possibile l'uso utilizzato con una chiave dinamometrica secondo le specifiche del produttore
- per:
 - BGS 35339, 19 mm,
 - BGS 35334, 24 mm, pinze freni SAF su MERCEDES-BENZ Atego e Actros
 - BGS 35336, 26 mm, DAF - XF95 / XF105 / XF
 - BGS 35330, 30 mm



PRO+

BSG articolo	DESCRIZIONE
BGS 35310	SET 5 PEZZI, CHIAVI A PERCUSSIONE POLIGONALI E TORX

CARATTERISTICHE

- per connessioni a vite pinza freno da assali anteriori e posteriori di veicoli commerciali
- per Mercedes-Benz, MAN, DAF
- comprende:
 - 1 chiave poligonale, 24 mm (BGS 35334)
 - 1 chiave poligonale, 26 mm (BGS 35336)
 - 1 chiave Torx femmina, E18 (BGS 35318)
 - 1 chiave Torx femmina, E20 (BGS 35320)
 - 1 chiave Torx femmina, E24 (BGS 35324)
- peso 3,9 kg



POLIGONALE

**CHIAVI A CRICCHETTO BRUNITE CON
DOPPIA BUSSOLA POLIGONALE
ALTA RESISTENZA**

FEIMEC articolo	mm	L mm	
RH 1013	10 x 13	240	1
RH 1317	13 x 17	280	1
BGS 308	17 x 19	315	1
BGS 310	19 x 22	315	1
BGS 309	17 x 21	315	1
RH 2122	21 x 22	315 PER PONTEGGI	1
BGS 311	19 x 24	360	1
RH 2427	24 x 27	360	1
BGS 305	24 x 30	360	1
BGS 306	27 x 32	360	1
RH 3032	30 x 32	450	1
RH 3641	36 x 41	450	1
RH 46	46 MISURA UNICA	500	1
RH 50	50 MISURA UNICA	500	1
RH 55	55 MISURA UNICA	500	1



POLIGONALE

**CHIAVI A CRICCHETTO BRUNITE CON
DOPPIA BUSSOLA POLIGONALE LUNGA
PER PONTEGGI IMPUGNATURA CON
RIVESTIMENTO IN GOMMA**

FEIMEC articolo	mm	L mm	
RHLP-2122	21 x 22	320	1



NEW

POLIGONALE **PRO+** **CV**

BGS articolo	DESCRIZIONE
BGS 6907	CHIAVE A CRICCHETTO PER PONTEGGI, STELO TONDO, 19 X 22 MM

CARATTERISTICHE
• cricchetto reversibile, 24 denti
• albero forgiato
• chiavi poligonali da 19 e 22 mm
• lunghezza: 310 mm
• peso: 600 g



**CORDONE IN ACCIAIO CON RIVESTIMENTO
IN PLASTICA + 2 MOSCHETTONI
QUESTO CORDONE APPLICATO
ALLA CHIAVE ED ALLA CINTURA
DELL'OPERATORE, PREVIENE LA CADUTA
DELL'UTENSILE DURANTE I LAVORI AD
ALTA QUOTA**

FEIMEC articolo	Descrizione	
36721	BLISTER	1



NEW

BGS articolo	DESCRIZIONE
BGS 70910	CHIAVE A CRICCHETTO PER PONTEGGI, 3-IN-1, 19 X 22 MM

CARATTERISTICHE
• reversibile
• con tre funzioni: aiuta ad evitare il cambio di strumenti attraverso più funzioni aggiunte
• teste forgiate
• con testa di martello su entrambi i lati
• manico appuntito
• cricchetto a 24 denti ad alta resistenza
• lunghezza: 310 mm
• materiale: acciaio al carbonio (C45)
• con bussole poligonali da 19 e 22 mm
• peso 570 g



NEW

POLIGONALE **CV** **PRO+**

BGS articolo	DESCRIZIONE
BGS 6696	CHIAVE A CRICCHETTO PER PONTEGGI, 4 IN 1, 19 X 22 MM

CARATTERISTICHE
• reversibile
• cricchetto a 28 denti ad alta resistenza
• con quattro funzioni
- con testa a martello forgiata
- con strappachiodi sulla testa
- impugnatura a cuneo
- con bussole poligonali 19 e 22 mm
• impronta: poligonale
• lunghezza: 311,6 mm
• peso: 490 g



NEW

BGS articolo	DESCRIZIONE
BGS 6777	CHIAVE A CRICCHETTO PER PONTEGGI, 4 IN 1, 19 X 22 MM

CARATTERISTICHE
• reversibile
• con quattro funzioni:
- con testa a martello forgiata
- con strappachiodi sulla testa
- impugnatura a cuneo
- con bussole poligonali 19 e 22 mm
• cricchetto a 24 denti ad alta resistenza
• impronta bussole: poligonali
• lunghezza: 300 mm
• peso 630 g

CHIAVI A CRICCHETTO PER EDILIZIA

5 CHIAVI DINAMOMETRICHE

MOTO



1/4" PRO+

BGS articolo	DESCRIZIONE
BGS 8511	SET 11 PEZZI, CHIAVE DINAMOMETRICA PER RAGGI, CON TESTE INTERCAMBIABILI

CARATTERISTICHE

- 10 teste intercambiabili con attacco **9 x 12 mm**, adatto per le misure di raggio più comuni: 5,1 - 5,8 - 6,1 - 6,3 - 6,4 - 6,5 - 6,7 - 6,9 mm
- testa a cricchetto quadro 1/4", 24 denti, per bussole
- range di torsione: da 3 a 15 Nm
- con pulsante di sgancio
- lunghezza: 195 mm
- peso: 920 g



1/4" PRO+ CV

BGS articolo	DESCRIZIONE
BGS 8856	SET 10 PEZZI, CHIAVE DINAMOMETRICA, 6 - 30 NM

CARATTERISTICHE

- per teste con attacco rettangolare **9 x 12 mm**
- testa chiave a cricchetto reversibile con attacco quadro 1/4"
- 8 teste a forchetta intercambiabili delle seguenti misure: 7 - 8 - 9 - 10 - 11 - 12 - 13 - 14 mm
- peso: 1,7 kg



BGS 958-REPAIR

1/2" PRO+ CV

BGS articolo	DESCRIZIONE
BGS 958	SET 11 PEZZI, CHIAVE DINAMOMETRICA, 40-210 NM

CARATTERISTICHE

- 9 chiavi a estremità aperta: 13-14-15-17-19-22-24-27-30 mm
- attacco rettangolare teste a forchetta intercambiabili: **14 x 18 mm**
- certificato di calibrazione incluso
- peso: 4,5 kg

RICAMBI

BGS articolo	DESCRIZIONE
BGS 958-REPAIR	SET RIPARAZIONE
BGS 958-LEER	CASSETTA VUOTA



PRO+ CV
CHIAVI DINAMOMETRICHE CON ATTACCO RETTANGOLARE **9 x 12 MM**

BGS articolo	mm	Nm	L mm
BGS 2814	9 x 12	5 - 25	230
BGS 2815	9 x 12	10 - 100	370

CARATTERISTICHE

- Dx e Sx
- per teste con attacco rettangolare: **9 x 12 mm**
- con rilascio automatico mediante segnale clic
- tolleranza: +/- 4%
- scala:
 - BGS 2814: 0,1 Nm
 - BGS 2815: 0,5 Nm
- fornite con certificato di calibrazione

NEW



PRO+
CHIAVI DINAMOMETRICHE CON ATTACCO RETTANGOLARE **14 x 18 MM**

BGS articolo	mm	Nm	L mm
BGS 2816	14 x 18	20 - 200	490
BGS 2817	14 x 18	40 - 340	560

CARATTERISTICHE

- Dx e Sx
- per teste con attacco rettangolare: **14 x 18 mm**
- con rilascio automatico mediante segnale clic
- tolleranza: +/- 4%
- scala:
 - BGS 2814: 1 Nm
 - BGS 2815: 2 Nm
- fornite con certificato di calibrazione



CV 1/4" PRO+

BGS articolo	DESCRIZIONE
BGS 2813	SET 10 PEZZI, CHIAVE DINAMOMETRICA, ATT. 1/4", 10-50 NM

CARATTERISTICHE

- con teste intercambiabili
- testa a cricchetto reversibile, con meccanismo a cricchetto con 48 denti, con attacco quadro 1/4" (6.3 mm)
- per teste con attacco rettangolare **9 x 12 mm**
- 8 teste a forchetta delle misure attacco rettangolare 9 x 12 mm: 7 - 8 - 9 - 10 - 11 - 12 - 13 - 14 mm
- precisione: +/- 4%, comprende certificato di prova
- range di coppia: 10 - 50 Nm
- scala: 0,5 Nm
- finestra di visualizzazione per il valore della coppia
- peso: 1,9 kg

NEW



PRO+

**CHIAVI DINAMOMETRICHE
CON ATTACCO RETTANGOLARE
9 X 12 MM**

BGS articolo	mm	Nm	L mm
BGS 2809	9 x 12	10 - 50	375
BGS 2810	9 x 12	20 - 100	375

CARATTERISTICHE

- Dx
- per teste con attacco rettangolare: **9 x 12 mm**
- con rilascio automatico mediante segnale clic
- tolleranza: +/- 4%
- scala 0.5 Nm

NEW

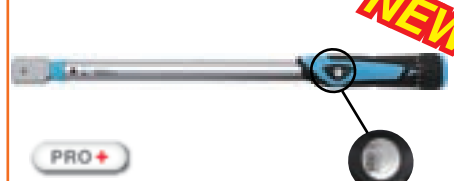

PRO+

**CHIAVI DINAMOMETRICHE
CON ATTACCO RETTANGOLARE
14 X 18 MM**

BGS articolo	mm	Nm	L mm
BGS 2811	14 x 18	40 - 200	495
BGS 2812	14 x 18	60 - 340	600

CARATTERISTICHE

- Dx
- per teste con attacco rettangolare: **14 x 18 mm**
- con rilascio automatico mediante segnale clic
- tolleranza: +/- 4%
- scala 1 Nm

NEW



PRO+

**TESTE A CRICCHETTO
CON ATTACCO RETTANGOLARE**

BGS articolo	ATTACCO mm	SGANCIO RAPIDO
BGS 2819	1/4" 9 x 12	SI
BGS 2820	3/8" 9 x 12	SI
BGS 2821	1/2" 9 x 12	SI
BGS 2822	1/2" 14 x 18	SI
BGS 2823	3/4" 14 x 18	NO

CARATTERISTICHE

- attacco rettangolare
- con perno di bloccaggio
- cricchetto 72 denti
- pulsante di sgancio rapido
- conforme DIN 3120, ISO 1174-1
- finitura satinata cromata
- per uso con chiavi dinamometriche con attacco rettangolare

CV **PRO+** **POLIGONALE**



**TESTE POLIGONALI
PER CHIAVI DINAMOMETRICHE,
ATTACCO RETTANGOLARE 9 X 12 MM**

BGS articolo	DESCRIZIONE
BGS 6902-7	7 MM
BGS 6902-8	8 MM
BGS 6902-10	10 MM
BGS 6902-11	11 MM
BGS 6902-12	12 MM
BGS 6902-13	13 MM
BGS 6902-14	14 MM
BGS 6902-15	15 MM
BGS 6902-16	16 MM
BGS 6902-17	17 MM
BGS 6902-18	18 MM
BGS 6902-19	19 MM
BGS 6902-21	21 MM
BGS 6902-22	22 MM

CARATTERISTICHE

- attacco rettangolare: **9 x 12 mm**
- con perno di bloccaggio
- finitura satinata cromata

NEW

CV **PRO+** **POLIGONALE**



**TESTE POLIGONALI
PER CHIAVI DINAMOMETRICHE,
ATTACCO RETTANGOLARE 14 X 18 MM**

BGS articolo	DESCRIZIONE
BGS 6903-13	13 MM
BGS 6903-14	14 MM
BGS 6903-15	15 MM
BGS 6903-16	16 MM
BGS 6903-17	17 MM
BGS 6903-18	18 MM
BGS 6903-19	19 MM
BGS 6903-21	21 MM
BGS 6903-22	22 MM
BGS 6903-24	24 MM
BGS 6903-27	27 MM
BGS 6903-30	30 MM
BGS 6903-32	32 MM
BGS 6903-34	34 MM
BGS 6903-36	36 MM
BGS 6903-41	41 MM

CARATTERISTICHE

- attacco rettangolare: **14 x 18 mm**
- con perno di bloccaggio
- finitura satinata cromata

CV **PRO+**



**TESTE A FORCHETTA
PER CHIAVI DINAMOMETRICHE,
ATTACCO RETTANGOLARE 9 X 12 MM**

BGS articolo	DESCRIZIONE
BGS 6900-7	7 MM
BGS 6900-8	8 MM
BGS 6900-9	9 MM
BGS 6900-10	10 MM
BGS 6900-11	11 MM
BGS 6900-12	12 MM
BGS 6900-13	13 MM
BGS 6900-14	14 MM
BGS 6900-15	15 MM
BGS 6900-16	16 MM
BGS 6900-17	17 MM
BGS 6900-18	18 MM
BGS 6900-19	19 MM

CARATTERISTICHE

- attacco rettangolare: **9 x 12 mm**
- con perno di bloccaggio
- finitura satinata cromata

NEW

CV **PRO+**



**TESTE A FORCHETTA
PER CHIAVI DINAMOMETRICHE,
ATTACCO RETTANGOLARE 14 X 18 MM**

BGS articolo	DESCRIZIONE
BGS 6901-13	13 MM
BGS 6901-14	14 MM
BGS 6901-15	15 MM
BGS 6901-16	16 MM
BGS 6901-17	17 MM
BGS 6901-18	18 MM
BGS 6901-19	19 MM
BGS 6901-21	21 MM
BGS 6901-24	24 MM
BGS 6901-27	27 MM
BGS 6901-30	30 MM
BGS 6901-32	32 MM
BGS 6901-34	34 MM
BGS 6901-36	36 MM
BGS 6901-38	36 MM
BGS 6901-41	41 MM

CARATTERISTICHE

- attacco rettangolare: **14 x 18 mm**
- con perno di bloccaggio
- finitura satinata cromata

5 CHIAVI DINAMOMETRICHE



CV

PRO+

POLIGONALE

TESTE POLIGONALI APERTE
PER CHIAVI DINAMOMETRICHE,
ATTACCO RETTANGOLARE 9 X 12 MM

BGS articolo	DESCRIZIONE
BGS 6904-10	10 MM
BGS 6904-11	11 MM
BGS 6904-12	12 MM
BGS 6904-13	13 MM
BGS 6904-14	14 MM
BGS 6904-16	16 MM
BGS 6904-17	17 MM
BGS 6904-18	18 MM
BGS 6904-19	19 MM
BGS 6904-21	21 MM
BGS 6904-22	22 MM

CARATTERISTICHE

- attacco rettangolare: 9 x 12 mm
- con perno di bloccaggio
- finitura satinata cromata



1/4"

PRO+

CACCIAVITE DINAMOMETRICO

BGS articolo	Nm	L mm
BGS 975	1-5	235

CARATTERISTICHE

- adattatore porta inserti incluso
- lunghezza 235 mm
- scala graduata in "finestra"
- rilascio automatico mediante segnale clic
- precisione: +/- 6%
- peso 650 g



1/4"

PRO+

CACCIAVITE DINAMOMETRICO

BGS articolo	Nm
BGS 8661	2-10

CARATTERISTICHE

- attacco quadro da 1/4"
- autobloccante
- segnale acustico "clic" al raggiungimento della coppia impostata
- particolarmente indicata per il serraggio dei sensori del sistema di monitoraggio pressione pneumatici (TPMS)
- peso 440 g

JAPAN



CHIAVE DINAMOMETRICA PER CANDELE

Koken articolo	Nm	L mm
3751 J-25	25	178



1/4"

PRO+

BGS articolo	DESCRIZIONE
BGS 954	CHIAVE DINAMOMETRICA, 1-6 NM

CARATTERISTICHE

- cricchetto reversibile con pulsante di sgancio rapido
- "click" al raggiungimento della coppia impostata
- solo uso Dx
- tolleranza: +/- 4%
- fornita con certificato di calibrazione
- peso 420 g



PRO+

CHIAVI DINAMOMETRICHE A SCATTO

BGS articolo	Nm	L mm
BGS 960	5-25	280
BGS 959	5-25	280
BGS 962	7-105	380
BGS 98	28-210	470
BGS 964	70-350	630

CARATTERISTICHE

- chiave a cricchetto reversibile con rilascio automatico mediante segnale clic
- regolazione coppia mediante vite di arresto
- art. BGS 98 con adattatore 3/8" e prolunga 125 mm
- in cassetta in plastica



CHIAVE DINAMOMETRICA

articolo	Nm	L mm
BCS 961	13,6-108,5	280

CARATTERISTICHE

- regolazione coppia mediante vite di arresto
- lunghezza: circa 280 mm
- include adattatore 3/8" F - 1/2" M
- peso 940 g



CHIAVE DINAMOMETRICA REVERSIBILE

articolo	Nm	L mm
BCS 2798	70-350	650

CARATTERISTICHE

- reversibile
- arresto automatico tramite segnale a clic
- quadro passante per il cambio di direzione
- rilascio automatico mediante segnale clic
- coppia regolabile mediante dispositivo di arresto
- lunghezza: 650 mm
- peso 3,0 kg

NEW



CHIAMI DINAMOMETRICHE, ISOLATE VDE, 1000 V

articolo	Nm	L mm
FM 307-3/8-2-25	2 - 25	280
FM 308-1/2-5-50	5 - 50	370

CARATTERISTICHE

- conformi DIN EN 60900
- isolati VDE fino a 1000 V



CHIAVI DINAMOMETRICHE A SCATTO

articolo	Nm	L mm
BCS 98	28-210	470

CARATTERISTICHE

- chiave a cricchetto reversibile con rilascio automatico mediante segnale clic
- regolazione coppia mediante vite di arresto
- con adattatore 3/8" e prolunga 125 mm
- in cassetta in plastica
- peso 1,9 kg



CHIAVI DINAMOMETRICHE A SCATTO

articolo	Nm	L mm
BCS 967	6-30	285
BCS 966	20-110	355
BCS 965	42-210	500
BCS 971	70-350	550
BCS 968	100-500	850
BCS 969	140-700	1000
BCS 990	140-980	1235
BCS 970	140-980	1230

CARATTERISTICHE

- chiave a cricchetto reversibile con rilascio automatico mediante segnale clic
- coppia regolabile mediante dispositivo di arresto
- alta precisione
- fornita con certificato di calibrazione



CHIAVI DINAMOMETRICHE REVERSIBILI

articolo	Nm	L mm
BCS 987	2-24	275
BCS 988	19-110	290
BCS 963	28-210	450
BCS 957 NEW	40-210	467
BCS 6653 NEW	70-350	640
BCS 9576	140-980	830
BCS 9577	140-980	830

CARATTERISTICHE

- con cricchetto reversibile
- solo uso Dx
- regolazione coppia mediante vite di arresto

5 CHIAVI DINAMOMETRICHE



PRO+

REVERSIBILE
Sx Dx

CHIAVI DINAMOMETRICHE

BGS articolo	mm	Nm		L mm
BGS 2803	1/4"	5-25	SX & DX	320
BGS 2804	3/8"	20-100	SX & DX	401
BGS 2805	1/2"	40-200	SX & DX	500
BGS 2806	1/2"	60-340	SX & DX	604

CARATTERISTICHE

- cricchetto reversibile a 48 denti
- finestra per visualizzare la coppia
- tolleranza: +/- 4%



PRO+

CHIAVI DINAMOMETRICHE

BGS articolo	mm	Nm		L mm
BGS 2807	3/4"	150-750	DX	1210
BGS 2808	1"	200-1000	DX	1500

CARATTERISTICHE

- cricchetto reversibile a 48 denti
- finestra per visualizzare la coppia
- tolleranza: +/- 4%



PRO+

REVERSIBILE
Sx Dx

DIGITALI

CHIAVE DINAMOMETRICA DIGITALE

BGS articolo	mm	Nm		Precisione	Dimensioni mm	L mm
BGS 952	1/4"	6 - 30	SX & DX	+/- 4%	290 x 35 x 35	290
BGS 951	3/8"	27 - 135	SX & DX	+/- 2%	380 x 35 x 35	380
BGS 950	1/2"	40 - 200	SX & DX	+/- 2%	480 x 40 x 40	480

CARATTERISTICHE

- per una precisa regolazione della coppia
- con cricchetto a 72 denti
- display digitale
- la coppia attuale è sempre mostrata sul display quando si lavora
- segnale acustico al raggiungimento della coppia preimpostata
- **Sx & Dx**
- risoluzione: 0.1 Nm
- capacità di memoria: 50 set di dati
- unità di misura: Kg-cm, Kg-m, lb-in, lb-ft, N-m
- batteria: 1,5V AAA (2 pezzi)
- temperatura di funzionamento: da -10 °a 60 °C
- umidità di funzionamento: da 15 % a 90 %
- autospegnimento dopo 80 secondi, quando non in uso

NEW



1/2"



BGS articolo	DESCRIZIONE
BGS 6835	CHIAVE DINAMOMETRICA A CROCE, ATT. 1/2", 70 - 170 NM

CARATTERISTICHE

- solo uso Dx
- coppia limitata solo in senso orario
- può essere usato come una chiave a croce senza coppia per allentare (in senso antiorario)
- con "modalità rapida" per un rapido allentamento e serraggio
- smontabile per risparmiare spazio
- range coppia: 70 - 170 Nm
- attacco quadro maschi 1/2"
- precisione: +/- 4%
- tipo: segnale acustico "click"
- scala fine: 1 Nm
- lunghezza:
 - impugnatura: 230 mm
 - traversa: 490 mm
- comprende 3 bussole: 17 - 19 - 21 mm
- peso 2,1 kg

NEW



BGS articolo	DESCRIZIONE
BGS 2818	SET CAMBIO GOMME, CON CHIAVE DINAMOMETRICA 40-200 NM

CARATTERISTICHE

- set di servizio per il cambio gomme
- ideale per il cambio delle ruote sui cerchi più diffusi
- bussole rivestite con protezione in plastica con codifica colore, adatte per uso a mano e a macchina
- con barra di torsione per pre-serraggio dadi con avvitatori ad impulsi: l'arresto automatico di serraggio previene danni a cerchi e viti
- comprende:
 - chiave dinamometrica attacco 1/2"
 - testa a cricchetto, reversibile, 48 denti
 - DX
 - finestra per visualizzare la coppia
 - tolleranza: +/- 4%
 - coppia: 40 - 200 Nm
 - scala fine: 0,5 Nm
 - lunghezza: 500 mm
 - bussola a macchina rivestita in plastica, att. 1/2", 17 mm (BGS 7201)
 - bussola a macchina rivestita in plastica, att. 1/2", 19 mm (BGS 7202)
 - bussola a macchina rivestita in plastica, att. 1/2", 21 mm (BGS 7203)
 - barra di torsione, 120 Nm, lunghezza: 195 mm (BGS 185-120)
- peso: 3,2 Kg

NEW



BGS articolo	DESCRIZIONE
BGS 9679	SET 5 PEZZI, PER CAMBIO GOMME

CARATTERISTICHE

- comprende:
 - chiave dinamometrica, 28-210 Nm (BGS 98)
 - set 3 pezzi, bussole a macchina rivestite in plastica, 17 - 19 - 21 mm (BGS 7200)
 - tappetino paraginocchia, 450 x 210 x 30 mm (BGS 4801)
 - guanti da lavoro, taglia 10 (BGS 9954)
 - chiave a croce per ruote, 17 x 19 x 21 x 1/2" (BGS 1459)
- peso: 4,4 Kg

NEW



BGS articolo	DESCRIZIONE
BGS 70190	SET 5 PEZZI, CHIAVI DINAMOMETRICHE

CARATTERISTICHE

- funzione cricchetto reversibile
- particolarmente adatte per auto, moto e biciclette
- regolazione coppia mediante vite di arresto
- solo uso Dx
- con segnale di "click" al raggiungimento della coppia
- con cricchetto a 24 denti
- precisione: +/- 4%
- in cassetta
- comprende:
 - 1 chiave dinamometrica, attacco 1/2", 28 - 210 Nm, lunghezza 470 mm
 - 1 chiave dinamometrica, attacco 1/4", 2 - 24 Nm, lunghezza 265 mm
 - adattatore, quadro femmina 1/2" - quadro maschio 3/8"
 - adattatore portainseriti, esagono femmina 1/4" - quadro femmina 1/4"
 - prolunga, attacco 1/2" lunghezza 125 mm
- peso 2,8 kg



PRO+

CASSETTA VUOTA PER CHIAVI DINAMOMETRICHE

BGS articolo	DESCRIZIONE
BGS 98-LEER	PER BGS 98
BGS 964-LEER	PER BGS 964
BGS 965-LEER	PER BGS 965
BGS 6653-LEER	NEW PER BGS 6653

CARATTERISTICHE

- cassetta in plastica



MISURATORE ELETTRONICO DI COPPIA

articolo	DESCRIZIONE
BGS 979	1/4" 6-30 NM
BGS 978	3/8" 27-135 NM

CARATTERISTICHE

- applicato ad una chiave a cricco, questa può essere usata come una chiave dinamometrica
- precisione +/- 2%
- DX e SX

RICAMBI

articolo	DESCRIZIONE
BGS 9700	BATTERIA CR2032



articolo	DESCRIZIONE
BGS 70210	MISURATORE DIGITALE DI COPPIA, 1/2", 40 - 200 NM

CARATTERISTICHE

- adatto per il serraggio dei collegamenti a vite secondo la coppia specificata
- può essere usato come dispositivo di serraggio controllato con qualsiasi elemento di azionamento come un cricchetto reversibile
- per un serraggio controllato Dx e Sx
- precisione di misurazione molto elevata, documentata da un certificato di prova
- display LCD illuminato
- modalità di visualizzazione: Traccia - Track (visualizzazione continua) e Picco - Peak (rilevamento del valore di picco)
- funzione di spegnimento automatico
- il raggiungimento della coppia desiderata è indicato da un segnale acustico (buzzer)
- attacco quadro femmina: 1/2"
- attacco quadro maschio: 1/2"
- range coppia: 40 - 200 Nm
- risoluzione: 0,1 Nm
- precisione: +/- 2 %
- dimensioni: 125 x 35 x 40 mm
- capacità di memoria: 50 set di dati
- modalità di funzionamento: Picco e traccia
- selezione dell'unità: Kg-cm, lb-in, lb-ft, N-m
- alimentazione: batteria 1,5 V AAA (x2)
- temperatura di funzionamento: da -10 °C a 60 °C
- temperatura di stoccaggio:
 - da -20 °C a 70 °C
 - umidità: 15% - 90%
- peso 390 g



SET RIPARAZIONE PER CHIAVI DINAMOMETRICHE

articolo	DESCRIZIONE
BGS 958-REPAIR	PER BGS 958
BGS 959-REPAIR	PER BGS 959
BGS 962-REPAIR	PER BGS 962
BGS 965-REPAIR	PER BGS 965
BGS 966-REPAIR	PER BGS 966
BGS 967-REPAIR	PER BGS 967 E BGS 960
BGS 968-REPAIR	PER BGS 968 E BGS 990
BGS 969-REPAIR	PER BGS 969 E BGS 990
BGS 970-REPAIR	PER BGS 970
BGS 971-REPAIR	PER BGS 971 E BGS 964
BGS 973-REPAIR	PER BGS 973
BGS 2798-REPAIR	PER BGS 2798
BGS 2799-REPAIR	PER BGS 2799
BGS 2800-REPAIR	PER BGS 2800
BGS 2801-REPAIR	PER BGS 2801
BGS 2803-REPAIR	PER BGS 2803
BGS 2804-REPAIR	PER BGS 2804
BGS 2805-REPAIR	PER BGS 2805
BGS 2806-REPAIR	PER BGS 2806
BGS 2807-REPAIR	PER BGS 2807
BGS 2808-REPAIR	PER BGS 2808



BGS 2315-REPAIR **BGS 1204-REPAIR**



1/2" 3/4" PRO+

BGS articolo	DESCRIZIONE
BGS 1204	SET 6 PEZZI, MOLTIPLICATORE DI COPPIA, 1/2" + 3/4"

CARATTERISTICHE

- attacco da 1/2", coppia max. 300 Nm
- attacco da 3/4", coppia max. 1000 Nm
- rapporto di trasmissione 1:4; rapporto di coppia 1:3,3
- lunghezza totale (con manico dritto) 460 mm
- in alternativa, può essere combinato con una barra angolare sovrapposta al cerchio
- include chiave a cricchetto da 1/2" con sgancio rapido (dentatura fine) e impugnatura snodata per una rotazione facile e veloce
- comprende adattatore 3/4" F x 1/2" M
- peso 4,2 kg

RICAMBI

BGS articolo	DESCRIZIONE
BGS 1204-LEER	CASSETTA VUOTA
BGS 2315-REPAIR	SET RIPARAZIONE CRICCHETTO
BGS 1204-REPAIR	SET RIPARAZIONE MOLTIPLICATORE DI COPPIA



BGS 1230-REPAIR



1" PRO+

BGS articolo	DESCRIZIONE
BGS 1231	MOLTIPLICATORE DI COPPIA DA 1"

CARATTERISTICHE

- per allentare i dadi bloccati delle ruote di camion e furgoni
- coppia massima: 3200 Nm
- rapporto di trasmissione 1:56
- 7 bussole incluse
- misure bussole: 24-27-30-32-33-36-38 mm
- peso 11,5 kg

RICAMBI

BGS articolo	DESCRIZIONE
BGS 1230-REPAIR	SET RIPARAZIONE MOLTIPLICATORE DI COPPIA BGS1230-1, BGS1231 E MT-3000



1" ESAGONO

BUSSOLA 1", LUNGHEZZA 80 MM

FERMEC articolo	DESCRIZIONE
FM 1231-30	30 MM
FM 1231-32	32 MM
FM 1231-33	33 MM

CARATTERISTICHE

- ricambio per set moltiplicatori di coppia attacco quadro 1" BGS 1230-1, BGS1231
- lunghezza 80 mm



1" PRO+

BGS articolo	DESCRIZIONE
BGS 1230-REPAIR	SET DI RIPARAZIONE PER MOLTIPLICATORE DI COPPIA BGS 1230-1, MT-3000 E BGS 1231

CARATTERISTICHE

- comprende tutte le parti essenziali per la riparazione
- peso 2,1 kg





1/2"

PRO+

BGS
tecnico
articolo

DESCRIZIONE

BGS 3070
INDICATORE
ANGOLARE DI COPPIA,
ATTACCO QUADRO 1/2"

CARATTERISTICHE

- per funzionamento in combinazione con chiavi dinamometriche, cricchetti, bussole e altri accessori
- per l'impostazione precisa del numero di gradi necessari per determinate applicazioni
- scala 90 mm Ø, 0-360°, step di 2°
- peso 180 g



1/2"



PRO+

BGS
tecnico
articolo

DESCRIZIONE

BGS 3170
INDICATORE
ANGOLARE DI COPPIA
ATTACCO QUADRO
1/2", BRACCIO
MAGNETICO

CARATTERISTICHE

- consente di definire con precisione il numero di giri richiesto in un unico passaggio
- capacità max.: 280 Nm
- peso 480 g



1/2"

PRO+

BGS
tecnico
articolo

DESCRIZIONE

BGS 3169
INDICATORE
ANGOLARE DI COPPIA
ATTACCO QUADRO
1/2", BRACCIO CON
MORSETTO

CARATTERISTICHE

- consente di definire con precisione il numero di giri richiesto in un unico passaggio
- capacità max. 280 Nm
- peso 480 g



1/2"

PRO+



CV

BGS
tecnico
articolo

DESCRIZIONE

BGS 3084
INDICATORE
ANGOLARE DI COPPIA,
ATTACCO QUADRO 1/2"

CARATTERISTICHE

- scala: 0-360 °
- vite di arresto
- con chiave tipo L
- peso 190 g



3/4"

PRO+

BGS
tecnico
articolo

DESCRIZIONE

BGS 8439
INDICATORE
ANGOLARE DI COPPIA
ATTACCO QUADRO
3/4", BRACCIO
MAGNETICO

CARATTERISTICHE

- permette un'accurata regolazione dei gradi richiesti
- step di 2°
- braccio magnetico flessibile
- peso 630 g