

CACCIAVITI E CHIAVI A MANO

| | | | |
|-----|------------|----------------------------------|---|
| PAG | 230 | IMPUGNATURE PORTAINSERTI |  |
| PAG | 235 | CACCIAVITI |  |
| PAG | 241 | CACCIAVITI ISOLATI VDE |  |
| PAG | 243 | SET CACCIAVITI |  |
| PAG | 251 | CACCIAVITI A PERCUSSIONE |  |
| PAG | 252 | CHIAVI A BUSSOLA CON IMPUGNATURA |  |
| PAG | 258 | CHIAVI MASCHIO QUADRO |  |
| PAG | 259 | CHIAVI MASCHIO ESAGONALI |  |
| PAG | 274 | CHIAVI MASCHIO TORX |  |
| PAG | 281 | CHIAVI MASCHIO TORX CON FORO |  |
| PAG | 283 | CHIAVI MASCHIO RIBE |  |
| PAG | 283 | CHIAVI MASCHIO XZN |  |
| PAG | 283 | CHIAVI MASCHIO PENTALOBATE |  |

4 IMPUGNATURE PORTAINSERTI

IMPUGNATURE PORTAINSERTI

CRICCHETTO REVERSIBILE
attacco: 1/4"

| | | | | |
|---------------|------|------|------|---|
| FERMEC | | H mm | L mm | |
| articolo | 1/4" | 20 | 115 | 1 |
| 15630 | | | | |

MINI CRICCHETTO PORTA INSERTI REVERSIBILE
attacco: 1/4"

| | | | | |
|----------------|------|------|------|---|
| FERMEC | | H mm | L mm | |
| articolo | 1/4" | 20 | 100 | 1 |
| 5119701 | | | | |

CRICCHETTO PORTA INSERTI DOPPIO PIEGATO MAGNETICO REVERSIBILE
attacco: 1/4" - 5/16"

| | | | |
|---------------|---------------|------|---|
| FERMEC | | L mm | |
| articolo | 1/4" 5/16" | 120 | 1 |
| 51614 | | | |

CRICCHETTO REVERSIBILE PORTA INSERTI E BUSSOLE 1/4"

| | | | | |
|---------------|------|------|------|---|
| FERMEC | | H mm | L mm | |
| articolo | 1/4" | 30 | 140 | 1 |
| 3739 | | | | |

BGS
articolo
BGS 115

DESCRIZIONE
CHIAVE A CRICCHETTO "ULTRA-SOTTILE" CON INSERTI TAGLIO E CROCE

CARATTERISTICHE

- per spazi ridottissimi
- cricchetto reversibile DX e SX
- spessore cricchetto senza inserto 5 mm
- spessore cricchetto con inserto 11 mm
- lunghezza: **100 mm**
- finitura cromata
- comprende inserti:
 - Taglio: 3 - 5 mm
 - PH: PH1 - PH2
- peso 70 g

GHIERA DI MANOVRA PER SPAZI RIDOTTI

CRICCHETTO CON GHIERA DI MANOVRA PER SPAZI RIDOTTI

attacco: 1/4"

| | | | |
|---------------|------|------|---|
| FERMEC | | L mm | |
| articolo | 1/4" | 90 | 1 |
| 15614 | | | |

CRICCHETTO REVERSIBILE CON SNODO
attacco: 1/4"

| | | | |
|---------------|------|------|---|
| FERMEC | | L mm | |
| articolo | 1/4" | 120 | 1 |
| 15941 | | | |

BGS
articolo
BGS 354

DESCRIZIONE
CRICCHETTO PORTAINSERTI ATT. 1/4", LUNGH. 105 MM

CARATTERISTICHE

- per l'inserimento di inserti senza necessità di adattatore
- lunghezza: 105 mm
- peso 130 g

BGS
articolo
BGS 4838

DESCRIZIONE
IMPUGNATURA PORTAINSERTI XXL

CARATTERISTICHE

- lunghezza: 480 mm
- comprende:
 - testa con portainseri attacco 1/4" esagonale
 - impugnatura laterale
- l'azione sulla testa avviene tramite rotazione dell'impugnatura
- peso 270 g



SNODO

CHIAVE A "T" SNODATA CON MANDRINO PORTA INSERTI 1/4" - ASTA SCORREVOLE SGANCIO RAPIDO

| | | | |
|----------|------|------|---|
| articolo | 1/4" | L mm | 1 |
| 85414 | 1/4" | 450 | 1 |



10 mm PRO+

| | |
|--------------|---|
| BGS articolo | DESCRIZIONE |
| BGS 353 | CRICCHETTO PORTAINSERTI ATT. 10 MM, LUNGH. 135 MM |



1/4"

MINI IMPUGNATURA MAGNETICA CON TESTA GIREVOLE

attacco: 1/4"

| | | | |
|----------|------|------|---|
| articolo | 1/4" | L mm | 1 |
| 14001 | 1/4" | 85 | 1 |

JAPAN



1/4" 5/16"

CRICCHETTO PORTA INSERTI REVERSIBILE

attacco: 1/4" e 5/16"

| | | | |
|--------------|-------|------|---|
| articolo | 1/4" | L mm | 1 |
| 2749P-1/4HF | 1/4" | 125 | 1 |
| 2749P-5/16HF | 5/16" | 125 | 1 |

CARATTERISTICHE

- per l'inserimento di inserti senza necessità di adattatore
- lunghezza: 135 mm
- peso 270 g

NEW



ESAGONO 10 mm. CV PRO+

| | |
|--------------|--|
| BGS articolo | DESCRIZIONE |
| BGS 6656 | CRICCHETTO REVERSIBILE PORTAINSERTI, ATT. 10 MM, LUNGH. 240 MM |



1/4"

MINI IMPUGNATURA MAGNETICA

attacco: 1/4"

| | | | |
|----------|------|------|---|
| articolo | 1/4" | L mm | 1 |
| 14009 | 1/4" | 80 | 1 |

CARATTERISTICHE

- cricchetto reversibile 72 denti
- impugnatura ergonomica antiscivolo in materiale bi-componente
- attacco esagono femmina 10 mm
- lunghezza 240 mm
- peso: 370 g

JAPAN



SNODO

1/4" 5/16"

CRICCHETTO PORTA INSERTI REVERSIBILE SNODATO

attacco: 1/4" e 5/16"

| | | | |
|--------------|-------|------|---|
| articolo | 1/4" | L mm | 1 |
| 2774P-1/4HF | 1/4" | 165 | 1 |
| 2774P-5/16HF | 5/16" | 165 | 1 |



1/4"

PRO+ CV

IMPUGNATURA PORTA INSERTI CON 2 ATTACCHI 1/4"

attacco: 1/4"

| | | | |
|------------|------|------|---|
| articolo | 1/4" | L mm | 1 |
| BGS 7985-1 | 1/4" | 120 | 1 |



5/16" PRO+

| | |
|--------------|---|
| BGS articolo | DESCRIZIONE |
| BGS 3559 | PORTAINSERTI REVERSIBILE PER INSERTI 5/16" (8 MM) |

CARATTERISTICHE

- lunghezza 240 mm
- peso 160 g

4 IMPUGNATURE PORTAINSERTI

IMPUGNATURE PORTAINSERTI



IMPUGNATURA PORTA INSERTI CON 2 ATTACCHI 1/4"

attacco: 1/4"

| | | | |
|---------------------|------|------|---|
| BGS articolo | | L mm | |
| BGS 7988-1 | 1/4" | 120 | 1 |



IMPUGNATURA PORTA INSERTI ATTACCO 1/4" CON BLOCCAGGIO

attacco: 1/4"

| | | | |
|------------------------|------|------|---|
| FERMEC articolo | | L mm | |
| 10459 | 1/4" | 130 | 1 |

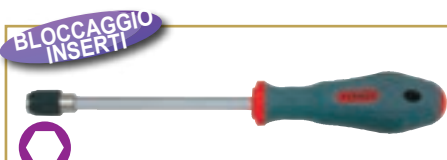

IMPUGNATURA CON MAGNETE E BLOCCAGGIO RAPIDO DELL'INSERTO

attacco: 1/4"

| | | | |
|------------------------|------|------|---|
| FERMEC articolo | | L mm | |
| 14315 | 1/4" | 220 | 1 |



IMPUGNATURA PORTA INSERTI TIPO CORTO CON MAGNETE

attacco: 1/4"

| | | | |
|------------------------|------|------|---|
| FERMEC articolo | | L mm | |
| 14010 | 1/4" | 140 | 1 |



IMPUGNATURA PORTA INSERTI CON MAGNETE

attacco: 1/4"

| | | | |
|------------------------|------|------|---|
| FERMEC articolo | | L mm | |
| 14015 | 1/4" | 250 | 1 |



IMPUGNATURA PORTA INSERTI CON MAGNETE

attacco: 1/4"

| | | | |
|------------------------|------|------|---|
| FERMEC articolo | | L mm | |
| 14016 | 1/4" | 220 | 1 |



| | | | |
|--|--|-------------|--|
| | | PRO+ | |
|--|--|-------------|--|

| | |
|---------------------|--|
| BGS articolo | DESCRIZIONE |
| BGS 217 | IMPUGNATURA PORTA INSERTI, LUNGHEZZA 200 MM |

CARATTERISTICHE

- impugnatura in materiale bi-componente
- lunghezza 200 mm
- peso 90 g



IMPUGNATURA PORTA INSERTI CON MAGNETE

attacco: 1/4"

| | | | |
|------------------------|------|------|---|
| FERMEC articolo | | L mm | |
| 37033 | 1/4" | 190 | 1 |

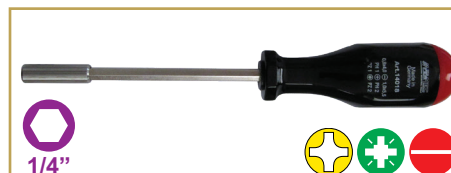

IMPUGNATURA PORTA INSERTI CON MAGNETE + SERBATOIO CON 6 INSERTI:
- PH 1, PH 2
- PZ 1, PZ 2
- TAGLIO: 0.8 X 4.0 - 1.0 X 5.5

attacco: 1/4"

| | | | |
|------------------------|------|------|---|
| FERMEC articolo | | L mm | |
| 14018 | 1/4" | 230 | 1 |



IMPUGNATURA PORTA INSERTI CON MAGNETE E GAMBO FLESSIBILE RICOPERTO

attacco: 1/4" - 5/16"

| | | | |
|------------------------|------|------|---|
| FERMEC articolo | | L mm | |
| 14012 FLEX | 1/4" | 260 | 1 |



| | |
|---------------------|---|
| BGS articolo | DESCRIZIONE |
| BGS 7829 | IMPUGNATURA PORTAINSERTI MAGNETICA, ATTACCO 1/4", GAMBO FLESSIBILE |

CARATTERISTICHE

- magnetica
- lunghezza 260 mm
- impugnatura antiscivolo in materiale bi-componente
- peso 180 g



IMPUGNATURA A "T" CON MAGNETE

attacco: 1/4"

| | | | |
|-----------------|------|------|---|
| FEFMEC articolo | 1/4" | L mm | 1 |
| 14030 | 1/4" | 150 | 1 |



IMPUGNATURA PORTA INSERTI CON MAGNETE + ISOLAMENTO "VDE" SERBATOIO CON 6 INSERTI PH - PZ - TAGLIO

attacco: 1/4"

| | | | |
|-----------------|------|------|---|
| FEFMEC articolo | 1/4" | L mm | 1 |
| 14020 | 1/4" | 230 | 1 |



IMPUGNATURA PORTA INSERTI CON MAGNETE + ISOLAMENTO "VDE" SERBATOIO CON 6 INSERTI TORX®

attacco: 1/4"

| | | | |
|-----------------|------|------|---|
| FEFMEC articolo | 1/4" | L mm | 1 |
| 14021 TX | 1/4" | 230 | 1 |



IMPUGNATURA PORTA INSERTI CON MAGNETE + SERBATOIO CON 4 INSERTI PH1 - PH2 E TAGLIO

attacco: 1/4"

| | | | |
|-----------------|------|------|---|
| FEFMEC articolo | 1/4" | L mm | 1 |
| 40638 | 1/4" | 190 | 1 |



LUNGHEZZA REGOLABILE

BGS 9150

| DESCRIZIONE |
|--|
| IMPUGNATURA PORTA INSERTI MAGNETICA A CRICCHETTO REVERSIBILE CON REGOLAZIONE DI LUNGHEZZA DELL'ASTA |

CARATTERISTICHE

- meccanismo a cricchetto reversibile a 18 denti
- magnetico
- lunghezza dell'asta regolabile da 35 a 145 mm
- lunghezza complessiva da 200 a 305 mm
- impugnatura in materiale bi-componente
- peso 200 g



USH GERMANY

IMPUGNATURA PORTA INSERTI MAGNETICA A CRICCO REVERSIBILE CON REGOLAZIONE DI LUNGHEZZA DELL'ASTA A FRIZIONE E SERBATOIO CON OTTO INSERTI

attacco: 1/4"

| Descrizione | 1 |
|-----------------------|---------------------------|
| FEFMEC articolo 42020 | IMPUGNATURA PORTA INSERTI |
| 42020 E | ESPOSITORE 12 PEZZI |



PHILLIPS® POZIDRIV® TAGLIO

| DESCRIZIONE |
|--|
| ESPOSITORE 12 PEZZI, MINI-GIRAVITE MULTIFUNZIONE 8 IN 1 |

CARATTERISTICHE

- espositore da banco da 12 pezzi
- impugnatura con rivestimento anticivolo
- lunghezza complessiva: 95 mm
- una sola lama per 8 impronte:
 - Taglio 6 x 1,0 mm
 - PH0, PH1, PH2, PH3
 - PZ1, PZ2, PZ3



lunghezza 125 mm

una sola lama per più impronte!

100 mm

205 mm

| DESCRIZIONE |
|--|
| ESPOSITORE 12 PEZZI, GIRAVITE MULTIFUNZIONE |

CARATTERISTICHE

- espositore da banco da 12 pezzi
- impugnatura con rivestimento anticivolo
- lama magnetica doppia punta lunghezza 125 mm
- una sola lama per 5 impronte:
 - Taglio 6 x 1,0 mm
 - PH0, PH1, PH2, PH3

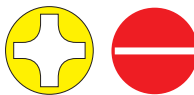

RONDELLA MAGNETICA

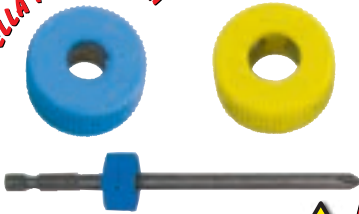

RONDELLA MAGNETICA PER INSERTI E LAME CACCIAVITE



| FEIMEC articolo | PER Ø MAX MM | MISURE |
|-----------------|--------------|-------------|
| MAG. 6 | 6,5 | Ø 19 X 10 H |
| MAG. 8 | 8 | Ø 19 X 10 H |

CARATTERISTICHE

- per magnetizzare inserti e cacciaviti con il semplice inserimento della lama nel foro della rondella

BGS 9560

BGS 9561



MAGNETE

| BGS articolo | DESCRIZIONE |
|--------------|-------------|
| BGS 9560 | MAGNETE |
| BGS 9561 | MAGNETE |

CARATTERISTICHE

- per magnetizzare punte di cacciaviti, utensili e piccole parti ferrose
- viti e altre piccole parti ferrose saranno attratti senza problemi allo strumento grazie al magnete
- consente di magnetizzare e smagnetizzare facilmente



| FEIMEC articolo | DESCRIZIONE |
|-----------------|-----------------------------|
| BIG FLEXI | MAGNETE PER LAME CACCIAVITI |

CARATTERISTICHE

- inserito nella lama del cacciavite trattiene le viti con un magnete in testa
- Ø max 6 mm - Ø min 4 mm



| BGS articolo | DESCRIZIONE |
|--------------|---|
| BGS 78950 | "SCREW DOKTOR", PER MIGLIORARE L'ATTRITO, 40 GRAMMI |

CARATTERISTICHE

- consente una presa migliore quando si avvitano e svitano viti
- aumenta l'attrito tra l'utensile e la vite fino al 500%
- una goccia è sufficiente per una vite
- peso 40 g



| BGS articolo | DESCRIZIONE |
|--------------|--|
| BGS 70049 | SET 4 PEZZI, CACCIAVITI STANDARD "JIS" |

CARATTERISTICHE

- adatto per viti con impronta a croce conforme allo standard industriale giapponese (JIS)
- impronta speciale hanno con dimensioni e angoli diversi da una vite PH
- l'uso di un cacciavite standard PH rovina la testa delle viti JIS
- adatto per viti su prodotti giapponesi, come, ad esempio, per veicoli e motociclette
- impugnatura con foro
- punte magnetizzate
- comprende:
 - 1 cacciaviti JIS 1 x 75 mm
 - 1 cacciaviti JIS 2 x 38 mm
 - 1 cacciaviti JIS 2 x 100 mm
 - 1 cacciaviti JIS 3 x 150 mm
- impugnature ergonomiche in materiale bi-componente
- finitura: satinata
- peso 400 g

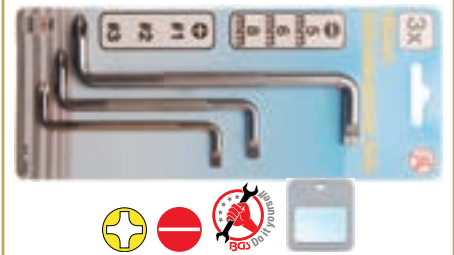

| BGS articolo | DESCRIZIONE |
|--------------|--------------------------------|
| BGS 7982 | SET 3 PEZZI, CHIAVI DOPPIE A L |

CARATTERISTICHE

- Taglio: 5-6-8 mm
- PH: 1-2-3
- peso 140 g



CHIAVI MASCHIO TAGLIO CON IMPUGNATURA A "T"

| Kokon articolo | mm | L mm | box |
|----------------|----|------|-----|
| 157 S-6 | 6 | 200 | 1 |
| 157 S-8 | 8 | 250 | 1 |

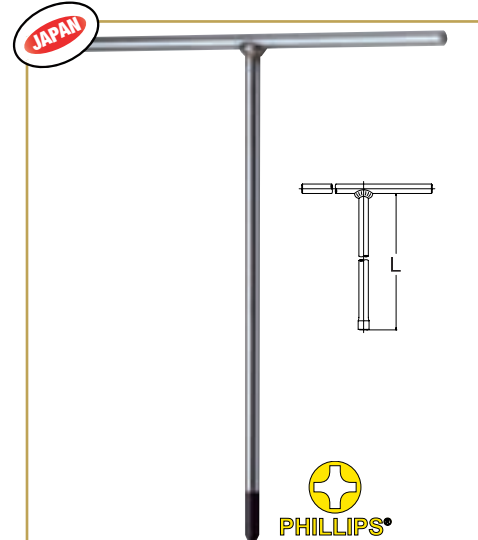

CHIAVI MASCHIO PHILLIPS CON IMPUGNATURA A "T"



| Kokon articolo | PH | L mm | box |
|----------------|------|------|-----|
| 157 PE-PH2 | PH 2 | 250 | 1 |
| 157 PE-PH3 | PH 3 | 250 | 1 |



PHILLIPS®



MINI CACCIAVITE CON TESTA GIREVOLE

| #FERMEC articolo |  | L mm |  |
|------------------|---|------|---|
| 8780-PH00 | PH 00 | 60 | 1 |
| 8780-PH0 | PH 0 | 60 | 1 |
| 8780-PH1 | PH 1 | 80 | 1 |







PHILLIPS®

CACCIAVITE CON IMPUGNATURA IN MATERIALE BI-COMPONENTE
ALTA RESISTENZA - MADE IN GERMANY

| #FERMEC articolo |  | L mm |  |
|------------------|---|------|---|
| 5780-PH0-60 | PH 0 | 60 | 1/10 |
| 5780-PH1-80 | PH 1 | 80 | 1/10 |
| 5780-PH1-250 | PH 1 | 250 | 1/10 |
| 5780-PH1-300 | PH 1 | 300 | 1/10 |
| 5780-PH2-100 | PH 2 | 100 | 1/10 |
| 5780-PH2-250 | PH 2 | 250 | 1/10 |
| 5780-PH2-300 | PH 2 | 300 | 1/10 |
| 5780-PH3-150 | PH 3 | 150 | 1/10 |



PHILLIPS® PRO+ 



| BGS articolo |  | L mm |  |
|--------------|---|------|---|
| BGS 7910 | PH 0 | 75 | 1 |
| BGS 7911 | PH 1 | 75 | 1 |
| BGS 7912 | PH 2 | 38 | 1 |
| BGS 7913 | PH 2 | 100 | 1 |
| BGS 7914 | PH 3 | 150 | 1 |
| BGS 7915 | PH 4 | 200 | 1 |

CARATTERISTICHE

- lame a tutto stelo con esagono (tranne art. BGS 7910)
- impugnatura ergonomica a presa morbida





PHILLIPS® PRO+ 

| BGS articolo |  | L mm |  |
|--------------|---|------|---|
| BGS 4907 | PH 0 | 100 | 1 |
| BGS 4908 | PH 1 | 75 | 1 |
| BGS 4909 | PH 2 | 38 | 1 |
| BGS 4910 | PH 2 | 100 | 1 |
| BGS 4911 | PH 3 | 150 | 1 |
| BGS 4912 | PH 4 | 200 | 1 |

CARATTERISTICHE

- impugnatura antiscivolo bi-componente
- con attacco quadro da 1/4" (6,3 mm) nell'impugnatura (tranne art. BGS 4907)
- dalla cassetteria portautensili PRO+ BGS 4050





PHILLIPS® PRO+ 

| BGS articolo |  | L mm |
|--------------|---|------|
| BGS 4935 | PH 1 | 80 |
| BGS 4936 | PH 2 | 100 |
| BGS 4937 | PH 3 | 150 |

CARATTERISTICHE

- impugnatura in materiale bi-componente
- punte nere



PHILLIPS®  

| BGS articolo |  | L mm |
|--------------|---|------|
| BGS 7946-PH0 | PH 0 | 80 |
| BGS 7946-PH1 | PH 1 | 80 |
| BGS 7946-PH2 | PH 2 | 100 |
| BGS 7946-PH3 | PH 3 | 200 |

CARATTERISTICHE

- impugnatura ergonomica in materiale bi-componente
- dal set BGS 7946



PHILLIPS® 

| BGS articolo | DESCRIZIONE |
|--------------|--|
| BGS 729 | CACCIAVITE EXTRA-CORTO, PH 2, LUNGHEZZA 80 MM |

CARATTERISTICHE

- impugnatura in gomma antiscivolo
- peso 60 g



PHILLIPS®

CACCIAVITE NANO EXTRA CORTO
MADE IN GERMANY

| #FERMEC articolo |  | L mm |  |
|------------------|---|------|---|
| 281401 | PH 1 | 80 | 1/10 |



POZIDRIV®

**CACCIAVITE CON IMPUGNATURA IN
MATERIALE BI-COMPONENTE
ALTA RESISTENZA - MADE IN GERMANY**

| FEIMEC articolo | | L mm | |
|--------------------|------|------|------|
| 5782-PZ0-60 | PZ 0 | 60 | 1/10 |
| 5782-PZ1-80 | PZ 1 | 80 | 1/10 |
| 5782-PZ1-250 | PZ 1 | 250 | 1/10 |
| 5782-PZ1-300 | PZ 1 | 300 | 1/10 |
| 5782-PZ2-100 | PZ 2 | 100 | 1/10 |
| 5782-PZ2-250 | PZ 2 | 250 | 1/10 |
| 5782-PZ2-300 | PZ 2 | 300 | 1/10 |
| 5782-PZ3-150 | PZ 3 | 150 | 1/10 |



POZIDRIV®



BGS

CV



| BGS articolo | | L mm |
|-----------------|------|------|
| BGS 7946-PZ1 | PZ 1 | 100 |
| BGS 7946-PZ2 | PZ 2 | 125 |
| BGS 7946-PZ3 | PZ 3 | 200 |

CARATTERISTICHE

- impugnatura ergonomica in materiale bi-componente
- dal set BGS 7946



POZIDRIV®

PRO+



| BGS articolo | | L mm |
|-----------------|------|------|
| BGS 4932 | PZ 1 | 75 |
| BGS 4933 | PZ 2 | 100 |
| BGS 4934 | PZ 3 | 150 |

CARATTERISTICHE

- impugnatura in materiale bi-componente
- punte nere



TAGLIO

MINI CACCIAVITE CON TESTA GIREVOLE

| FEIMEC articolo | | mm | L mm | |
|--------------------|--|-----------|------|---|
| 8710-15 | | 0,3 x 1,5 | 60 | 1 |
| 8710-20 | | 0,4 x 2,0 | 60 | 1 |
| 8710-25 | | 0,4 x 2,5 | 75 | 1 |
| 8710-30 | | 0,5 x 3,0 | 100 | 1 |
| 8710-35 | | 0,6 x 3,5 | 100 | 1 |
| 8710-40 | | 0,8 x 4,0 | 100 | 1 |



TAGLIO

**CACCIAVITE CON IMPUGNATURA IN
MATERIALE BI-COMPONENTE
ALTA RESISTENZA - MADE IN GERMANY**

| FEIMEC articolo | | mm | L mm | |
|--------------------|--|------------|------|------|
| 5710-3 | | 0,5 x 3,0 | 75 | 1/10 |
| 5710-4 | | 0,8 x 4,0 | 75 | 1/10 |
| 5710-5 | | 0,8 x 5,0 | 100 | 1/10 |
| 5710-55 | | 1,0 x 5,5 | 125 | 1/10 |
| 5710-65 | | 1,2 x 6,5 | 150 | 1/10 |
| 5710-8 | | 1,2 x 8,0 | 175 | 1/10 |
| 5710-10 | | 1,6 x 10,0 | 175 | 1/10 |
| 5710-12 | | 2,0 x 12,0 | 250 | 1/10 |
| 5710-14 | | 2,5 x 14,0 | 250 | 1/10 |



TAGLIO

PRO+



| BGS articolo | | mm | L mm | |
|-----------------|--|-----|------|---|
| BGS 7916 | | 3,2 | 75 | 1 |
| BGS 7917 | | 5 | 75 | 1 |
| BGS 7918 | | 6 | 38 | 1 |
| BGS 7919 | | 6 | 100 | 1 |
| BGS 7920 | | 8 | 150 | 1 |
| BGS 7921 | | 9,5 | 200 | 1 |

CARATTERISTICHE

- lame a tutto stelo con esagono (tranne art. BGS 7916)
- impugnatura ergonomica a presa morbida
- con presa esagonale nell'impugnatura (tranne art. BGS 7916)

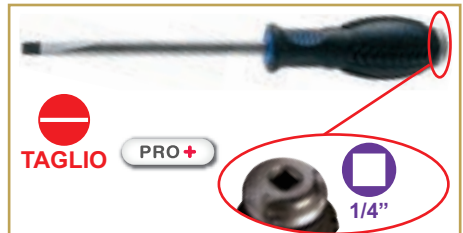

TAGLIO

PRO+



| BGS articolo | | mm | L mm | |
|-----------------|--|----|------|---|
| BGS 4901 | | 3 | 100 | 1 |
| BGS 4902 | | 5 | 75 | 1 |
| BGS 4903 | | 6 | 38 | 1 |
| BGS 4904 | | 6 | 100 | 1 |
| BGS 4905 | | 8 | 150 | 1 |
| BGS 4906 | | 10 | 200 | 1 |

CARATTERISTICHE

- impugnatura antiscivolo bi-componente
- con attacco quadro da 1/4" (6,3 mm) nell'impugnatura (tranne art. BGS 4901)
- dalla cassettera portautensili PRO+ BGS 4050





ESAGONO

IMPUGNATURA CON LAMA ESAGONALE

| FEIMEC articolo | mm | L mm | |
|--------------------|-----|------|---|
| 501-1,5 | 1,5 | 60 | 1 |
| 501-2 | 2 | 60 | 1 |
| 501-2,5 | 2,5 | 75 | 1 |
| 501-3 | 3 | 75 | 1 |
| 501-4 | 4 | 75 | 1 |
| 501-5 | 5 | 75 | 1 |
| 501-6 | 6 | 100 | 1 |
| 501-8 | 8 | 100 | 1 |



ESAGONO

PRO+

CV

| BGS articolo | mm | L mm | |
|-----------------|-----|------|---|
| BGS 8629-1 | 1,5 | 75 | 1 |
| BGS 8629-2 | 2 | 75 | 1 |
| BGS 8629-3 | 2,5 | 75 | 1 |
| BGS 8629-4 | 3 | 100 | 1 |
| BGS 8629-5 | 4 | 100 | 1 |
| BGS 8629-6 | 5 | 150 | 1 |
| BGS 8629-7 | 6 | 150 | 1 |
| BGS 8629-8 | 8 | 200 | 1 |

CARATTERISTICHE

- impugnatura antiscivolo in materiale bi-componente



ESAGONO

CACCIAVITE CON IMPUGNATURA IN MATERIALE BI-COMPONENTE ALTA RESISTENZA - MADE IN GERMANY

| FEIMEC articolo | mm | L mm | |
|--------------------|-----|------|------|
| 5790-15 | 1,5 | 75 | 1/10 |
| 5790-20 | 2,0 | 100 | 1/10 |
| 5790-25 | 2,5 | 100 | 1/10 |
| 5790-30 | 3,0 | 100 | 1/10 |
| 5790-40 | 4,0 | 100 | 1/10 |
| 5790-50 | 5,0 | 100 | 1/10 |
| 5790-60 | 6,0 | 125 | 1/10 |



SATINATE



ESAGONO

IMPUGNATURA CON LAMA ESAGONALE TESTA SFERICA

| FEIMEC articolo | mm | L mm | |
|--------------------|--------|------|---|
| 350-1,27 | 1,27 | 60 | 1 |
| 350-1,5 | 1,5 | 85 | 1 |
| 350-2 | 2 | 90 | 1 |
| 350-2,5 | 2,5 | 100 | 1 |
| 350-3 | 3 | 100 | 1 |
| 350-4 | 4 | 100 | 1 |
| 350-5 | 5 | 110 | 1 |
| 350-6 | 6 | 140 | 1 |
| 350-8 | 8 | 160 | 1 |
| 350-10 | 10 | 190 | 1 |
| 350-0/050" | 0/050" | 60 | 1 |
| 350-1/16" | 1/16" | 65 | 1 |
| 350-5/64" | 5/64" | 90 | 1 |
| 350-3/32" | 3/32" | 85 | 1 |
| 350-1/8" | 1/8" | 82 | 1 |
| 350-5/32" | 5/32" | 91 | 1 |
| 350-3/16" | 3/16" | 97 | 1 |
| 350-7/32" | 7/32" | 110 | 1 |
| 350-1/4" | 1/4" | 123 | 1 |
| 350-5/16" | 5/16" | 145 | 1 |
| 350-3/8" | 3/8" | 167 | 1 |

POLLICI

NOTE



TORX®
MINI CACCIAVITE CON TESTA GIREVOLE

| articolo | ★ | L mm | |
|----------|-------|------|---|
| 8792-T1 | TX 01 | 60 | 1 |
| 8792-T2 | TX 02 | 60 | 1 |
| 8792-T3 | TX 03 | 60 | 1 |
| 8792-T4 | TX 04 | 60 | 1 |
| 8792-T5 | TX 05 | 60 | 1 |
| 8792-T6 | TX 06 | 60 | 1 |
| 8792-T7 | TX 07 | 60 | 1 |
| 8792-T8 | TX 08 | 60 | 1 |
| 8792-T9 | TX 09 | 60 | 1 |
| 8792-T10 | TX 10 | 80 | 1 |
| 8792-T15 | TX 15 | 80 | 1 |
| 8792-T20 | TX 20 | 100 | 1 |



TORX®
CACCIAVITE CON IMPUGNATURA IN MATERIALE BI-COMPONENTE
ALTA RESISTENZA - MADE IN GERMANY

| articolo | ★ | L mm | |
|----------|-------|------|------|
| 5792-T5 | TX 05 | 70 | 1/10 |
| 5792-T6 | TX 06 | 70 | 1/10 |
| 5792-T7 | TX 07 | 70 | 1/10 |
| 5792-T8 | TX 08 | 70 | 1/10 |
| 5792-T9 | TX 09 | 70 | 1/10 |
| 5792-T10 | TX 10 | 80 | 1/10 |
| 5792-T15 | TX 15 | 80 | 1/10 |
| 5792-T20 | TX 20 | 90 | 1/10 |
| 5792-T25 | TX 25 | 90 | 1/10 |
| 5792-T27 | TX 27 | 110 | 1/10 |
| 5792-T30 | TX 30 | 110 | 1/10 |
| 5792-T40 | TX 40 | 120 | 1/10 |



TORX®
CACCIAVITE TORX®

| articolo | ★ | L mm | |
|----------|-------|------|---|
| 670-T5 | TX 05 | 50 | 1 |
| 670-T6 | TX 06 | 50 | 1 |
| 670-T7 | TX 07 | 50 | 1 |
| 670-T8 | TX 08 | 60 | 1 |
| 670-T9 | TX 09 | 60 | 1 |
| 670-T10 | TX 10 | 80 | 1 |
| 670-T15 | TX 15 | 80 | 1 |
| 670-T20 | TX 20 | 100 | 1 |
| 670-T25 | TX 25 | 100 | 1 |
| 670-T27 | TX 27 | 115 | 1 |
| 670-T30 | TX 30 | 115 | 1 |
| 670-T40 | TX 40 | 130 | 1 |
| 670-T45 | TX 45 | 130 | 1 |



TORX®

| articolo | ★ | L mm | |
|----------|-------|------|---|
| BGS 4913 | TX 06 | 80 | 1 |
| BGS 4914 | TX 07 | 80 | 1 |
| BGS 4915 | TX 08 | 80 | 1 |
| BGS 4916 | TX 09 | 80 | 1 |
| BGS 4917 | TX 10 | 80 | 1 |
| BGS 4918 | TX 15 | 80 | 1 |
| BGS 4919 | TX 20 | 80 | 1 |
| BGS 4920 | TX 25 | 80 | 1 |
| BGS 4921 | TX 27 | 100 | 1 |
| BGS 4922 | TX 30 | 100 | 1 |
| BGS 4923 | TX 40 | 150 | 1 |

CARATTERISTICHE

- impugnatura antiscivolo bi-componente



TORX®
CACCIAVITE TORX

| articolo | ★ | L mm | |
|--------------|-------|------|--|
| BGS 7844-T6 | TX 06 | 60 | |
| BGS 7844-T7 | TX 07 | 60 | |
| BGS 7844-T8 | TX 08 | 60 | |
| BGS 7844-T9 | TX 09 | 60 | |
| BGS 7844-T10 | TX 10 | 60 | |
| BGS 7844-T15 | TX 15 | 100 | |
| BGS 7844-T20 | TX 20 | 100 | |
| BGS 7844-T25 | TX 25 | 100 | |
| BGS 7844-T27 | TX 27 | 100 | |
| BGS 7844-T30 | TX 30 | 100 | |
| BGS 7844-T40 | TX 40 | 125 | |
| BGS 7844-T45 | TX 45 | 125 | |

CARATTERISTICHE

- impugnatura ergonomica in materiale bi-componente
- dal set BGS 7844



TORX®
CACCIAVITI TORX® EXTRA LUNGI CON IMPUGNATURA ANTISCIVOLO

| articolo | ★ | L mm | |
|--------------|-------|------|---|
| 5420-T9 | TX 09 | 300 | 1 |
| 5420-T10 | TX 10 | 300 | 1 |
| 5420-T15 | TX 15 | 300 | 1 |
| 5420-T20 | TX 20 | 300 | 1 |
| 5420-T25 | TX 25 | 300 | 1 |
| 5420-T27 | TX 27 | 300 | 1 |
| 5420-T30 | TX 30 | 300 | 1 |
| 5420-T30-400 | TX 30 | 400 | 1 |
| 5420-T40 | TX 40 | 300 | 1 |



TORX®
CACCIAVITE TORX

| articolo | ★ | L mm | |
|----------|-------|------|--|
| BGS 4944 | TX 15 | 250 | |
| BGS 4945 | TX 20 | 250 | |
| BGS 4946 | TX 25 | 250 | |
| BGS 4947 | TX 30 | 250 | |

CARATTERISTICHE

- extra-lunghi
- impugnatura in materiale bi-componente
- finitura satinata cromata



CACCIAVITE TORX® EXTRA LUNGI CON IMPUGNATURA ANTISCIVOLO PER AUDI - BMW - VW

| articolo | ★ | Ø lama mm | L mm | |
|-------------|-------|-----------|------|---|
| 168-T20-250 | TX 20 | 5 | 250 | 1 |
| 168-T25-250 | TX 25 | 5 | 250 | 1 |
| 168-T30-250 | TX 30 | 6 | 250 | 1 |



GERMANY



**TORX®
CON FORO**
**CACCIAVITE CON IMPUGNATURA IN
MATERIALE BI-COMPONENTE
ALTA RESISTENZA - MADE IN GERMANY**

| FEIMEC articolo | | L mm | |
|--------------------|-------|------|------|
| 5794-TH8 | TH 08 | 70 | 1/10 |
| 5794-TH9 | TH 09 | 70 | 1/10 |
| 5794-TH10 | TH 10 | 80 | 1/10 |
| 5794-TH15 | TH 15 | 80 | 1/10 |
| 5794-TH20 | TH 20 | 90 | 1/10 |
| 5794-TH25 | TH 25 | 90 | 1/10 |
| 5794-TH27 | TH 27 | 110 | 1/10 |
| 5794-TH30 | TH 30 | 110 | 1/10 |
| 5794-TH40 | TH 40 | 120 | 1/10 |

GERMANY



**TORX®
CON FORO**

| FEIMEC articolo | | L mm | |
|--------------------|-------|------|---|
| 680-TH7 | TH 07 | 50 | 1 |
| 680-TH8 | TH 08 | 60 | 1 |
| 680-TH9 | TH 09 | 60 | 1 |
| 680-TH10 | TH 10 | 80 | 1 |
| 680-TH15 | TH 15 | 80 | 1 |
| 680-TH20 | TH 20 | 100 | 1 |
| 680-TH25 | TH 25 | 100 | 1 |
| 680-TH27 | TH 27 | 115 | 1 |
| 680-TH30 | TH 30 | 115 | 1 |
| 680-TH40 | TH 40 | 130 | 1 |
| 680-TH45 | TH 45 | 140 | 1 |



**TORX®
CON FORO**

| FEIMEC articolo | | L mm | |
|--------------------|-------|------|---|
| BCS 7849-T8 | TH 08 | 80 | 1 |
| BCS 7849-T10 | TH 10 | 80 | 1 |
| BCS 7849-T15 | TH 15 | 80 | 1 |
| BCS 7849-T20 | TH 20 | 80 | 1 |
| BCS 7849-T25 | TH 25 | 100 | 1 |
| BCS 7849-T27 | TH 27 | 100 | 1 |
| BCS 7849-T30 | TH 30 | 100 | 1 |
| BCS 7849-T40 | TH 40 | 150 | 1 |

CARATTERISTICHE

- impugnatura antiscivolo bi-componente



**TORX®
CON FORO**
CACCIAVITI TORX® C/FORO EXTRA LUNGH

| FEIMEC articolo | | L mm | |
|--------------------|-------|------|---|
| 8800-TH8 | TH 08 | 300 | 1 |
| 8800-TH10 | TH 10 | 300 | 1 |
| 8800-TH15 | TH 15 | 300 | 1 |
| 8800-TH20 | TH 20 | 300 | 1 |
| 8800-TH25 | TH 25 | 300 | 1 |
| 8800-TH30 | TH 30 | 300 | 1 |
| 8800-TH40 | TH 40 | 300 | 1 |

GERMANY



TORX^{plus}
**CACCIAVITE CON IMPUGNATURA IN
MATERIALE BI-COMPONENTE
ALTA RESISTENZA - MADE IN GERMANY**

| FEIMEC articolo | | L mm | |
|--------------------|-------|------|------|
| 5796-IP 5 | IP 05 | 70 | 1/10 |
| 5796-IP 6 | IP 06 | 70 | 1/10 |
| 5796-IP 7 | IP 07 | 70 | 1/10 |
| 5796-IP 8 | IP 08 | 70 | 1/10 |
| 5796-IP 9 | IP 09 | 70 | 1/10 |
| 5796-IP 10 | IP 10 | 80 | 1/10 |
| 5796-IP 15 | IP 15 | 80 | 1/10 |
| 5796-IP 20 | IP 20 | 80 | 1/10 |
| 5796-IP 25 | IP 25 | 90 | 1/10 |
| 5796-IP 30 | IP 30 | 115 | 1/10 |



**TRI-WING
CACCIAVITI TRI-WING**

| FEIMEC articolo | | L mm | |
|--------------------|------|------|---|
| 87437 | TW 0 | 80 | 1 |
| 35674 | TW 1 | 80 | 1 |
| 35675 | TW 2 | 80 | 1 |
| 35676 | TW 3 | 100 | 1 |
| 35677 | TW 4 | 100 | 1 |



CACCIAVITE PER TELEFONI CELLULARI

| FEIMEC articolo | L mm | |
|--------------------|------|---|
| 3470 A | 60 | 1 |



**PENTALOBATA
CON FORO**
CACCIAVITI 5 PUNTE C/FORO PER VITI PENTALOBATE

| FEIMEC articolo | | L mm | |
|--------------------|-------|------|---|
| IPR-10 | TP 10 | 125 | 1 |
| IPR-15 | TP 15 | 125 | 1 |
| IPR-20 | TP 20 | 125 | 1 |
| IPR-25 | TP 25 | 125 | 1 |
| IPR-27 | TP 27 | 125 | 1 |
| IPR-30 | TP 30 | 125 | 1 |
| IPR-40 | TP 40 | 125 | 1 |
| IPR-45 | TP 45 | 125 | 1 |

JAPAN







**PENTALOBATA
CON FORO**
CACCIAVITE 5 PUNTE C/FORO PER VITI PENTALOBATE EXTRA LUNGH CON IMPUGNATURA ANTISCIVOLO

| Koken articolo | | Ø lama mm | L mm | |
|-------------------|-------|-----------|------|---|
| 168-PR20-250 | TP 20 | 5 | 250 | 1 |



GERMANY

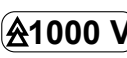





PHILLIPS   

CACCIAVITE ISOLATO VDE CON IMPUGNATURA IN MATERIALE BI-COMPONENTE ALTA RESISTENZA - MADE IN GERMANY

| FEIMEC articolo | PH | L mm | Box |
|-----------------|------|------|------|
| 578601 | PH 0 | 60 | 1/10 |
| 578602 | PH 1 | 80 | 1/10 |
| 578603 | PH 2 | 100 | 1/10 |
| 578604 | PH 3 | 150 | 1/10 |

GERMANY



TAGLIO   

CACCIAVITE ISOLATO VDE CON IMPUGNATURA IN MATERIALE BI-COMPONENTE ALTA RESISTENZA - MADE IN GERMANY

| FEIMEC articolo | mm | L mm | Box |
|-----------------|-----------|------|------|
| 577001 | 0,4 x 2,5 | 75 | 1/10 |
| 577002 | 0,5 x 3,0 | 100 | 1/10 |
| 577003 | 0,6 x 3,5 | 100 | 1/10 |
| 577004 | 0,8 x 4,0 | 100 | 1/10 |
| 577005 | 1,0 x 5,5 | 125 | 1/10 |
| 577006 | 1,2 x 6,5 | 150 | 1/10 |
| 577007 | 1,2 x 8,0 | 175 | 1/10 |

PHILLIPS   **PRO+** 

CACCIAVITE ISOLATO VDE CON IMPUGNATURA IN MATERIALE BI-COMPONENTE

| BGS articolo | PH | L mm |
|--------------|------|------|
| BGS 4942 | PH 0 | 75 |
| BGS 4926 | PH 1 | 80 |
| BGS 4927 | PH 2 | 100 |

TAGLIO  **PRO+** 



 

CACCIAVITE ISOLATO VDE CON IMPUGNATURA IN MATERIALE BI-COMPONENTE

| BGS articolo | mm | L mm |
|--------------|-----|------|
| BGS 4925 | 3,0 | 75 |
| BGS 4924 | 4,0 | 100 |
| BGS 4940 | 5,5 | 125 |
| BGS 4941 | 6,5 | 150 |

GERMANY

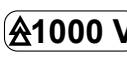

POZIDRIV   

CACCIAVITE ISOLATO VDE CON IMPUGNATURA IN MATERIALE BI-COMPONENTE ALTA RESISTENZA - MADE IN GERMANY

| FEIMEC articolo | PZ | L mm | Box |
|-----------------|------|------|------|
| 578701 | PZ 0 | 60 | 1/10 |
| 578702 | PZ 1 | 80 | 1/10 |
| 578703 | PZ 2 | 100 | 1/10 |
| 578704 | PZ 3 | 150 | 1/10 |

PRO+ 

BGS articolo

DESCRIZIONE

BGS 35812 **SET 2 PEZZI, CACCIAVITI ISOLATI VDE**

CARATTERISTICHE

- isolati VDE conformi normativa DIN 60900
- 1 cacciavite PH 2 x 100 mm
- 1 cacciavite Taglio 4 x 100 mm
- peso 170 g

POZIDRIV + TAGLIO   

CACCIAVITI ISOLATI A IMPRONTA MISTA, 1000 V, EN 60900

attacco: DIN 3126, E 6,35
impronta: PZ + TAGLIO

| FEIMEC articolo | Imp. | L mm | Box |
|-----------------|------------|------|-----|
| 5788PZ1 | PZ1+TAGLIO | 180 | 1 |
| 5788PZ2 | PZ2+TAGLIO | 205 | 1 |



  **PRO+**

BGS articolo

DESCRIZIONE

BGS 35838 **SET 8 PEZZI, CACCIAVITI ISOLATI VDE**

CARATTERISTICHE

- impugnatura ergonomica in materiale bi-componente
- conformi VDE/GS
- isolati VDE
- comprende:
 - 1 PH 0 x 75 mm
 - 1 PH 1 x 80 mm
 - 1 PH 2 x 100 mm
 - 1 taglio 0,5 x 3 x 75 mm
 - 1 taglio 0,8 x 4 x 100 mm
 - 1 taglio 1,0 x 5,5 x 125 mm
 - 1 taglio 1,2 x 6,5 x 150 mm
 - 1 cercafase con clip, taglio 0,5 x 3,0 x 140 mm
- peso 530 g



BGS articolo

DESCRIZIONE

BGS 35815 **SET 5 PEZZI, CACCIAVITI ISOLATI VDE**

CARATTERISTICHE

- impugnatura ergonomica in materiale bi-componente
- isolati VDE conformi normativa DIN 60900
- comprende:
 - 1 PH1 x 80 mm
 - 1 PH2 x 100 mm
 - 1 taglio 0,5 x 3 x 75 mm
 - 1 taglio 0,8 x 4 x 100 mm
 - 1 cercafase con clip 1 PH1 x 80 mm
- peso 270 g

4 SET CACCIAVITI ISOLATI VDE

SET CACCIAVITI ISOLATI VDE

MADE IN GERMANY

NEW

felo N°9
made in Germany

VDE

15

1000 V **D'E**

| felo articolo | DESCRIZIONE |
|---------------|---|
| FL N-9 | SET 7 PEZZI, CACCIAVITI ISOLATI VDE + METRO PIEGHEVOLE |

- CARATTERISTICHE**
- impugnatura ergonomica in materiale bi-componente
 - isolati VDE conformi normativa DIN 60900
 - comprende:
 - 1 PH1 x 80 mm
 - 1 PH2 x 100 mm
 - 1 taglio 0.4 x 2.5 x 75 mm
 - 1 taglio 0.8 x 2.5 x 100 mm
 - 1 taglio 1.0 x 2.5 x 100 mm
 - 1 taglio 1.5 x 2.5 x 100 mm
 - 1 metro pieghevole da 2 metri

felo

**DISPONIBILE
PROGRAMMA
COMPLETO
MADE IN
GERMANY
WWW.FERMEC.IT**

MADE IN GERMANY

NEW



**LAME DOPPIO USO:
POSSONO ESSERE USATE
CON L'IMPUGNATURA
O CON IL CAPPUCIO
COME CACCIAVITI DI PRECISIONE**

TAGLIO POZIDRIV® PHILLIPS® TORX®

1000 V **D'E**

| felo articolo | DESCRIZIONE |
|---------------|--|
| FL 063 913 06 | SET 14 PEZZI, CACCIAVITI ISOLATI VDE CON LAME INTERCAMBIABILI |

- CARATTERISTICHE**
- impugnatura ergonomica in materiale bi-componente con bloccaggio automatico delle lame, lunghezza 105 mm
 - isolati VDE conformi normativa DIN 60900
 - le lame possono essere usate con l'impugnatura o con il cappuccio compreso nella confezione, come cacciaviti di precisione con testa girevole
 - comprende 12 lame:
 - PH: PH1, PH2
 - Taglio: 2.5 x 0.4 - 3.0 x 0.5 - 3.5 x 0.6 - 4.0 x 0.8 - 5.5 x 1.0 - 6.5 x 1.2
 - PZ: PZ 1
 - Torx: TX 10 - TX 15 - TX 20



| BGS articolo | DESCRIZIONE |
|--------------|--|
| BGS 3319 | CUSTODIA DA CINTURA PER ATTREZZI IN TESSUTO |

- CARATTERISTICHE**
- vendita senza attrezzi
 - asola per martello
 - 7 tasche di varie misure
 - peso 140 g



D'E

| BGS articolo | DESCRIZIONE |
|--------------|---|
| BGS 35850 | TROUSSE PER ELETTRICISTI, CON 4 UTENSILI VDE + FORBICE |

- CARATTERISTICHE**
- comprende:
 - custodia da cintura vuota per attrezzi, in tessuto, BGS 3319
 - cacciavite isolato vde, PH1, BGS 4926
 - cacciavite isolato vde, PH2, BGS 4927
 - cacciavite isolato vde, Taglio 4,0 mm, BGS 4924
 - pinze profess. isolate vde, 180 mm, BGS 7150
 - forbici da elettricista in acciaio inox, 145 mm, BGS 7963



| | |
|------------------------|---|
| BGS articolo | DESCRIZIONE |
| BGS 7140 | SET 12 PEZZI, UTENSILI ISOLATI VDE |







CARATTERISTICHE

- impugnature in materiale bi-componente antiscivolo
- isolate, conformi DIN EN 60900
- cacciaviti isolati VDE con foro per appendere
- comprende:
 - tester di tensione, 120-250 Volt, lunghezza 140 mm (BGS 725)
 - cacciavite isolato VDE Taglio 3 mm, lunghezza lama 75 mm (BGS 4925)
 - cacciavite isolato VDE Taglio 4 mm, lunghezza lama 100 mm (BGS 4924)
 - cacciavite isolato VDE Taglio 5.5 mm, lunghezza lama 125 mm (BGS 4940)
 - cacciavite isolato VDE Taglio 6.5 mm, lunghezza lama 150 mm (BGS 4941)
 - cacciavite isolato VDE PH 0, lunghezza lama 75 mm (BGS 4942)
 - cacciavite isolato VDE PH 1, lunghezza lama 80 mm (BGS 4926)
 - cacciavite isolato VDE PH 2, lunghezza lama 100 mm (BGS 4927)
 - pinze professionali VDE, 180 mm (BGS 7150)
 - tronchesine taglio diagonale VDE 160 mm (BGS 7154)
 - pinze VDE a becchi mezzotondi diritti, 160 mm (BGS 7151)
 - pinze VDE a becchi mezzotondi diritti, 200 mm (BGS 7152)
 - custodia con zip
- peso 1,8 kg

SET 6 PEZZI CACCIAVITI TAGLIO E PH MATERIALE BI-COMPONENTE ALTA RESISTENZA - MADE IN GERMANY

| | |
|------------------------|-------------------------|
| BGS articolo | DESCRIZIONE |
| 8000 | SET 6 CACCIAVITI |

CARATTERISTICHE

-  1 Ph1, lunghezza 80 mm
-  1 Ph2, lunghezza 100 mm
-  1 taglio 0,5 x 3,0, lunghezza 75 mm
-  1 taglio 0,8 x 4,0, lunghezza 75 mm
-  1 taglio 1,0 x 5,5, lunghezza 75 mm
-  1 taglio 1,2 x 6,5, lunghezza 75 mm



| | |
|------------------------|--|
| BGS articolo | DESCRIZIONE |
| BGS 7944 | SET 7 PEZZI, CACCIAVITI PH E TAGLIO |

CARATTERISTICHE

- impugnatura antiscivolo in materiale bi-componente
- comprende:
 - Taglio: 4,0 x 80 mm - 5,5 x 125 mm - 6,5 x 150 mm - 8,0 x 200 mm
 - PH: PH1 x 80 mm; PH2 x 100 mm; PH3 x 200
- in scatola di cartone
- peso 850 g



| | |
|------------------------|--|
| BGS articolo | DESCRIZIONE |
| BGS 7943 | SET 5 PEZZI, CACCIAVITI PH E TAGLIO |

CARATTERISTICHE

- comprende:
 - Taglio: 4,0 x 80 mm - 5,5 x 125 mm - 6,5 x 150 mm
 - PH: PH1 x 80 mm; PH2 x 100 mm
- in scatola di cartone
- peso 470 g



| | |
|------------------------|--|
| BGS articolo | DESCRIZIONE |
| BGS 7946 | SET 5 PEZZI, CACCIAVITI PH E TAGLIO |

CARATTERISTICHE

- impugnatura ergonomica in materiale bi-componente
- punte magnetiche nere
- conforme DIN 5264
- comprende:
 - Taglio: 4,0 x 80 mm - 5,5 x 125 mm - 6,5 x 150 mm
 - PH: PH1 x 80 mm; PH2 x 100 mm
- in scatola di cartone
- peso 390 g

4 SET CACCIAVITI

SET CACCIAVITI

TAGLIO PHILLIPS®

CV

| | |
|------------------------|--|
| BGS articolo | DESCRIZIONE |
| BGS 35835 | SET 5 PEZZI, CACCIAVITI PH E TAGLIO |

CARATTERISTICHE

- comprende:
 - Taglio: 5 x 75 mm; 6 x 100 mm; 6 x 125 mm
 - PH: PH1 x 100 mm; PH2 x 125 mm
- punte nere magnetiche
- peso 490 g

PRO+ **CV**

| | |
|------------------------|--|
| BGS articolo | DESCRIZIONE |
| BGS 8629 | SET 8 PEZZI, CACCIAVITI ESAGONALI |

CARATTERISTICHE

- impugnatura antiscivolo in materiale bi-componente
- comprende:
 - 1,5 x 75 mm - 2,0 x 75 mm - 2,5 x 75 mm
 - 3,0 x 100 mm - 4,0 x 100 mm - 5,0 x 150 mm
 - 6,0 x 150 mm - 8,0 x 200 mm
- peso 740 g

GERMANY

SET 6 PEZZI CACCIAVITI TORX MATERIALE BI-COMPONENTE ALTA RESISTENZA - MADE IN GERMANY

| | |
|---------------------------|-------------------------------------|
| FERMEC articolo | DESCRIZIONE |
| 8060 | SET 6 PEZZI, CACCIAVITI TORX |

CARATTERISTICHE

- 1 Torx 10, lunghezza 80 mm
- 1 Torx 15, lunghezza 80 mm
- 1 Torx 20, lunghezza 90 mm
- 1 Torx 25, lunghezza 90 mm
- 1 Torx 30, lunghezza 110 mm
- 1 Torx 40, lunghezza 120 mm

NEW

TAGLIO POZIDRIV®

CV

| | |
|------------------------|--|
| BGS articolo | DESCRIZIONE |
| BGS 35816 | SET 6 PEZZI, CACCIAVITI PZ E TAGLIO |

CARATTERISTICHE

- punte magnetiche nere
- impugnatura ergonomiche in materiale bi-componente
- comprende:
 - 1 cacciavite isolato VDE Taglio 0.8 x 4 mm, lungh. lama 100 mm, testato VDE conforme DIN EN 60900
 - 1 cacciavite Taglio 5.5 mm, lungh. lama 75 mm
 - 1 cacciavite Taglio 6.5 mm, lungh. lama 100 mm
 - 1 cacciavite PZ 1, lungh. lama 80 mm
 - 1 cacciavite slot PZ 2, lungh. lama 100 mm
 - 1 tester Taglio 4 mm, 120 - 250 V, lungh. lama 140 mm
- peso: 390 g

CV **TORX®** **PRO+**

| | |
|------------------------|--|
| BGS articolo | DESCRIZIONE |
| BGS 7846 | SET 7 PEZZI, CACCIAVITI TORX, TX10 - TX40 |

CARATTERISTICHE

- misure:
 - TX10 X 80 mm- TX15 X 80 mm- TX20 X 80 mm
 - TX25 X 100 mm- TX27 X 100 mm - TX30 X 100 mm
 - TX40 X 150 mm
- lame satinare
- punte con finitura nera
- impugnature in materiale bi-componente
- in scatola di cartone
- peso 730 g

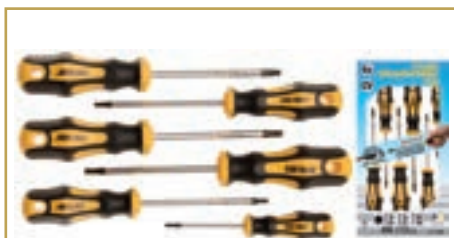

BGS
tecnologic
articolo

DESCRIZIONE

BGS 35826

**SET 6 PEZZI,
CACCIAVITI TORX,
TX10 - TX30**

CARATTERISTICHE

- misure: TX10 - TX15 - TX20 - TX25 - TX27 - TX30
- lame satinate
- punte con finitura nera
- impugnature ergonomiche in materiale bi-componente
- peso 450 g



BGS
tecnologic
articolo

DESCRIZIONE

BGS 4943

**SET 4 PEZZI,
CACCIAVITI TORX,
TX15-TX30,
LUNGHEZZA 250 MM**

CARATTERISTICHE

- misure: TX15 - TX20 - TX25 - TX30
- lunghezza lame: 250 mm
- punte con finitura nera
- impugnature in materiale bi-componente
- peso 530 g



BGS
tecnologic
articolo

DESCRIZIONE

BGS 7967

**SET 7 PEZZI,
CACCIAVITI DI
PRECISIONE TORX**

CARATTERISTICHE

- per utilizzo ovunque sia necessario un lavoro di precisione, come modellismo, elettronica, ecc.
- TX6 x 50 mm - TX7 x 50 mm - TX8 x 50 mm
- TX9 x 50 mm - TX10 x 50 mm - TX15 x 50 mm
- TX20 x 50 mm
- peso 250 g



BGS
tecnologic
articolo

DESCRIZIONE

BGS 7844

**SET 11 PEZZI,
CACCIAVITI TORX,
TX6 - TX40**

CARATTERISTICHE

- finitura satinata cromata
- punte nere magnetiche
- impugnatura ergonomica
- misure: TX 6-7-8-9-10-15-20-25-27-30-40
- peso 720 g



BGS
tecnologic
articolo

DESCRIZIONE

BGS 803

**SET 3 PEZZI,
CACCIAVITI DI
PRECISIONE TORX,
TX4-TX5-TX6**

CARATTERISTICHE

- ideali per uso su telefoni cellulari
- tutti i cacciaviti sono magnetici, con finitura satinata cromata e impugnatura morbida in gomma
- lunghezza 140 mm
- misure: TX4 - TX5 - TX6
- peso 100 g

4 SET CACCIAVITI

SET CACCIAVITI

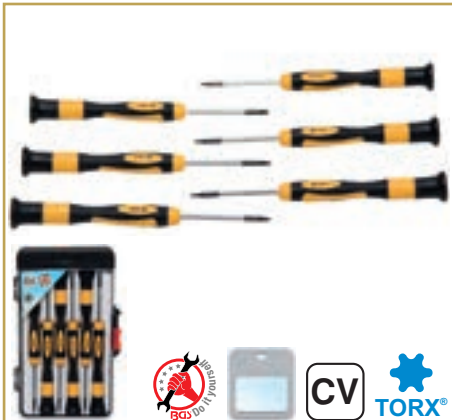

| | |
|------------------------|--|
| BGS articolo | DESCRIZIONE |
| BGS 35808 | SET 6 PEZZI, MINI CACCIAVITI CON TESTA GIREVOLE, TORX |

CARATTERISTICHE

- comprende le seguenti misure Torx: TX6 x 50 mm - TX7 x 50 mm - TX8 x 50 mm - TX9 x 50 mm - TX10 x 50 mm - TX15 x 50 mm
- con punte magnetiche
- impugnatura in materiale bi-componente
- lame in acciaio chrome vanadium
- lame satinata con punte con finitura nera
- in custodia rigida
- peso 200 g



| | |
|------------------------|---|
| BGS articolo | DESCRIZIONE |
| BGS 7841 | SET 7 PEZZI, CACCIAVITI TORX CON FORO, TH10-TH40 |

CARATTERISTICHE

- comprende: TH10 x 80 mm - TH15 x 80 mm - TH20 x 20 mm - TH25 x 100 mm - TH27 x 100 mm - TH30 x 100 mm - TH40 x 150 mm
- impugnatura antiscivolo in materiale bi-componente
- in scatola di cartone
- peso 710 g



| | |
|------------------------|---|
| BGS articolo | DESCRIZIONE |
| BGS 7845 | SET 11 PEZZI, CACCIAVITI TORX CON FORO |

CARATTERISTICHE

- impugnatura ergonomica in materiale bi-componente
- finitura satinata cromata
- punte nere magnetiche
- impugnatura ergonomica
- misure: TH 6-7-8-9-10-15-20-25-27-30-40
- peso 720 g



| | |
|------------------------|--|
| BGS articolo | DESCRIZIONE |
| BGS 7924 | SET 5 PEZZI, CACCIAVITI XZN, M4-M10 |

CARATTERISTICHE

- impugnatura antiscivolo in materiale bi-componente
- misure: M4, M5, M6, M8 e M10
- lunghezza lama: 300 mm
- lunghezza totale 400 mm
- materiale: Acciaio Chrome Vanadium
- peso 1,1 kg



BGS 7988-1



| | |
|------------------------|---------------------------------|
| BGS articolo | DESCRIZIONE |
| BGS 7988 | SET 11 PEZZI, CACCIAVITI |

CARATTERISTICHE

- satinati cromati
- con lame intercambiabili
- 20 in 1
- impugnatura con due attacchi 1/4" ergonomica
- comprende:
 - Taglio 4+6 mm - 5+7 mm
 - PH 1+2
 - PZ 1+2
 - Esagono:
 - 4 mm + 4 mm testa sferica
 - 5 mm + 5 mm testa sferica
 - 6 mm + 6 mm testa sferica
 - Torx: TX10+TX15, TX20+TX25, TX30+TX40
- peso 810 g

RICAMBI

| | |
|------------------------|--|
| BGS articolo | DESCRIZIONE |
| BGS 7988-1 | IMPUGNATURA CON 2 ATTACCHI 1/4" |



- SET 32 PEZZI CACCIAVITI ED INSERTI PROFESSIONALI
- 4 CACCIAVITI A TAGLIO
- 2 CACCIAVITI PHILLIPS®
- 1 IMPUGNATURA PORTA INSERTI MAGNETICA
- 25 INSERTI TORX® - TORX® C/FORO - BRUGOLA - PHILLIPS® - POZIDRIV®

| Descrizione | Quantità |
|-------------------|----------|
| CASSETTA 32 PEZZI | 1 |



| Descrizione |
|--|
| SET 12 PEZZI, CACCIAVITI CON QUADRO FEMMINA 1/4" |

- CARATTERISTICHE**
- con lama passante e attacco quadro femmina nell'impugnatura
 - permettono di esercitare più facilmente una forza maggiore
 - impugnatura ergonomica in materiale bi-componente
 - comprende (lunghezza della sola lama senza impugnatura):
 - Taglio: 3,0 x 100 mm (BGS 4901) - 5,0 x 75 mm (BGS 4902) - 6,0 x 100 mm (BGS 4904) - 6,0 x 38 mm (BGS 4903) - 8,0 x 150 mm (BGS 4905) - 10,0 x 200 mm (BGS 4906)
 - PH: PH0 x 100 mm (BGS 4907) - PH1 x 75 mm (BGS 4908) - PH2 x 100 mm (BGS 4910) - PH2 x 38 mm (BGS 4909) - PH3 x 150 mm (BGS 4911) - PH4 x 200 mm (BGS 4912)
 - peso 2,7 kg



| Descrizione |
|--|
| SET 12 PEZZI, CACCIAVITI CON LAMA PASSANTE E PRESA ESAGONALE |

- CARATTERISTICHE**
- con lama passante e attacco esagonale
 - impugnatura ergonomica
 - comprende (lunghezza della sola lama senza impugnatura ed attacco esagonale):
 - Taglio: 3,2x72 mm - 5,0x75 mm - 6,0x100 mm - 6,0x38 mm - 8,0x150 mm - 9,5x200 mm
 - PH: PH0x75 mm - PH1x75 mm - PH2x100 mm - PH2x38 mm - PH3x150 mm - PH4x200 mm
 - peso 2,7 kg

| Descrizione |
|----------------|
| CASSETTA VUOTA |



| Descrizione |
|--------------------------|
| SET 12 PEZZI, CACCIAVITI |

- CARATTERISTICHE**
- con punte magnetiche
 - con lama passante e attacco esagonale
 - impugnatura a presa morbida ergonomica
 - comprende:
 - cacciaviti Taglio: 3,2 x 72 mm - 5,0 x 75 mm - 6,0 x 100 mm - 6,0 x 38 mm - 8,0 x 150 mm - 9,5 x 200 mm
 - cacciaviti PH: PH0 x 75 mm - PH1 x 75 mm - PH2 x 100 mm - PH2 x 38 mm - PH3 x 150 mm - PH4 x 200 mm



| Descrizione |
|--------------------------|
| SET 12 PEZZI, CACCIAVITI |

- CARATTERISTICHE**
- lame esagonali a tutto stelo con esagono esterno per una maggiore coppia in caso di uso di una chiave o di una bussola
 - impugnatura ergonomica
 - comprende (lunghezza della sola lama senza impugnatura ed attacco esagonale):
 - Taglio: 3.2x75 mm - 5.0x75 mm - 6.0x38 mm - 6.0x100 mm - 7.0x150 mm - 8.0x200 mm
 - PH: PH0x75 mm - PH1x75 mm - PH2x100 mm - PH2x38 mm - PH3x150 mm, PH4x200 mm
 - peso 2,0 kg



| Descrizione |
|-------------------------|
| SET 5 PEZZI, CACCIAVITI |

- CARATTERISTICHE**
- punte magnetiche
 - con lama passante e attacco esagonale
 - per semplificare l'allentamento delle viti bloccate
 - comprende:
 - 1 cacciavite, PZ1, lunghezza lama 75 mm
 - 1 cacciavite, PZ2, lunghezza lama 100 mm
 - 1 cacciavite, Taglio 5 mm, lunghezza 75 mm
 - 1 cacciavite, Taglio 6 mm, lunghezza 100 mm
 - 1 cacciavite, Taglio 8 mm, lunghezza 150 mm
 - peso 490 g

4 SET CACCIAVITI

SET CACCIAVITI



Lama magnetica

- SERIE 4 PEZZI CACCIAVITI L. 450 MM SOLO LAMA
- 1 PHILLIPS® PH1
- 1 PHILLIPS® PH2
- 1 TAGLIO 4 mm
- 1 TAGLIO 6 mm

| articolo | | L mm | |
|----------|--------------------------------|------|---|
| 4645 PH1 | PH1 | 450 | 1 |
| 4645 PH2 | PH2 | 450 | 1 |
| 4645 T4 | TAGLIO 4 | 450 | 1 |
| 4645 T6 | TAGLIO 6 | 450 | 1 |
| 4645 | SERIE 4 CACCIAVITI EXTRA LUNGI | | 1 |



BGS 731 BGS 732



PRO +



| articolo | DESCRIZIONE |
|----------|--|
| BGS 730 | SET 2 PEZZI, CACCIAVITI, TAGLIO 6 MM E PH2, EXTRA- LUNGI |

CARATTERISTICHE

- lunghezza lama: 450 mm
- cacciaviti con lama quadra, con finitura nera
- impugnatura in materiale bi-componente
- comprende:
 - cacciavite Taglio 6 X 450 mm
 - cacciavite PH2 X 450 mm
- peso 360 g

RICAMBI

| articolo | DESCRIZIONE |
|----------|--|
| BGS 731 | CACCIAVITE LUNGHEZZA 450 MM, TAGLIO 6 MM |
| BGS 732 | CACCIAVITE LUNGHEZZA 450 MM PH 2 |



PENTALOBATA CON FORO TORX® CON FORO

PRO +

| articolo | DESCRIZIONE |
|----------|--|
| BGS 2325 | SET 8 PEZZI, INSERTI 5 PUNTE C/FORO, TORX C/FORO E IMPUGNATURA |

CARATTERISTICHE

- una lama a doppia estremità con profilo 5 punte c/ foro & TORX c/foro per ciascuna delle seguenti misure: 10-15-20-25-27-30-40
- impugnatura intercambiabile
- lunghezza lame 300 mm
- peso 660 g



TORX® TORX® CON FORO

| articolo | DESCRIZIONE |
|----------|---|
| BGS 2326 | SET 8 PEZZI, INSERTI TORX & TORX C/FORO E IMPUGNATURA |

CARATTERISTICHE

- ogni lama a doppia estremità Torx & Torx c/foro per ciascuna delle seguenti misure: 10 - 15 - 20 - 25 - 27 - 30 - 40
- lunghezza lame: 300 mm
- impugnatura intercambiabile con sfera di tenuta
- impugnatura anticivolo in materiale bi-componente
- peso 640 g



articolo



PRO +



| articolo | DESCRIZIONE |
|----------|---|
| BGS 7840 | SET 4 PEZZI, IMPUGNATURA E INSERTI SPECIALI |

CARATTERISTICHE

- per la regolazione ugelli tergitristalli
- impugnatura con due attacchi 1/4" esagonale
- lunghezza lame: 300 mm
- Esagonali: 6,7 mm
- Torx: TX25 per VW Sharan
- peso 410 g



BGS 7985-1



articolo



PRO +



CV

| articolo | DESCRIZIONE |
|----------|---|
| BGS 7985 | SET 19 PEZZI, CACCIAVITI SPECIALI CON IMPUGNATURA A "T" |

CARATTERISTICHE

- impugnatura con due attacchi 1/4" esagonale
- adattatore inserto
- portainseriti
- 8 lame con inserto a doppia estremità, 175 mm:
 - Esagono: 3, 4, 5, 6 mm con e senza testa sferica
 - Esagono: 7 mm testa sferica + Esagono 1/4"
 - Taglio: 4,5 + 6,5 mm
 - Torx: TX25+TX27 - TX30+TX40
 - 8 lame con chiave a bussola: 5-6-7-8-10-11-12-13 mm
- peso 1,7 kg

RICAMBI

| articolo | DESCRIZIONE |
|---------------|-----------------|
| BGS 7985-1 | IMPUGNATURA A T |
| BGS 7985-LEER | CASSETTA VUOTA |





|  articolo 8888 E | DESCRIZIONE |
|---|--|
| | ESPOSITORE 12 PEZZI, GIRAVITE MULTIFUNZIONE |

CARATTERISTICHE

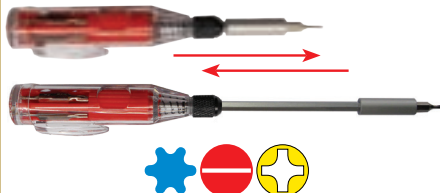
- espositore da banco da 12 pezzi
- impugnatura con rivestimento antiscivolo
- lama magnetica doppia punta lunghezza 125 mm
- una sola lama per 5 impronte:
 - Taglio 6 x 1,0 mm
 - PH0, PH1, PH2, PH3



- **CACCIAVITE A PENNA ESTENSIBILE**
- **12 INSERTI DI PRECISIONE**
PH00 - PH00 - PH0
TAGLIO MM 1,5-2-2,5
TORX® TX 4-5-6-7-8-10
- **IDEALE PER CELLULARI - COMPUTER -
ELETTRONICA - OCCHIALI...**

|  articolo 3412 | Descrizione |  1 |
|---|---|---|
| | CACCIAVITE A PENNA ESTENSIBILE | |
| 3412 E | ESPOSITORE 12 PEZZI | 1 |





4 mm.

OGNI IMPRONTA UN COLORE

- **SERIE 30 INSERTI DI PRECISIONE
COLORATI CON IMPUGNATURA**
- PH000 - PH00 - PH0 - PH1
PZ0 - PZ1
- **TAGLIO 1 - 1,5 - 2 - 2,5 - 3 - 3,5 - 4 MM**
- TORX® TX 4 - 5 - 6 - 7 - 8 - 9 - 10 - 15 - 20
- **ESAGONO 0,7 - 0,9 - 1,3 - 1,5 - 2 - 2,5 - 3 -
4 MM**

attacco: 4 mm

|  articolo BIT 130 COLOR | Descrizione |  1 |
|---|---------------------|--|
| | BOX 30 PEZZI | |



|  articolo BGS 8452 | DESCRIZIONE |
|--|--|
| | SET 11 PEZZI, INSERTI DI PRECISIONE |

CARATTERISTICHE

- comprende:
 - impugnatura ergonomica;
 - prolunga lunghezza 70 mm, con asta esagonale;
 - inserti Torx: TX4, TX5, TX6, TX7
 - inserti Taglio: 1,5 - 2,0 - 2,5 mm
 - inserti PH: 00, 0, 1
- inserti con attacco esagonale da 4 mm e codice colore
- peso 170 g



|  articolo 6666 E | DESCRIZIONE |
|---|--|
| | ESPOSITORE 12 PEZZI MINI- GIRAVITE MULTIFUNZIONE 8 IN 1 |

CARATTERISTICHE

- espositore da banco da 12 pezzi
- impugnatura con rivestimento antiscivolo
- lunghezza complessiva: 95 mm
- una sola lama per 8 impronte:
 - Taglio 6 x 1,0 mm
 - PH0, PH1, PH2, PH3
 - PZ1, PZ2, PZ3



|  articolo 8296 | DESCRIZIONE |
|--|--|
| | SET 6 PEZZI, MINI CACCIAVITI CON TESTA GIREVOLE PH E TAGLIO |

CARATTERISTICHE

- comprende le seguenti misure:
 - Taglio:
 - 0,3 x 1,5 x 60 mm
 - 0,4 x 2,0 x 60 mm
 - 0,4 x 2,5 x 75 mm
 - PH:
 - PH 00 x 60 mm
 - PH 0 x 60 mm
 - PH 1 x 80 mm
- in custodia in stoffa

4 SET CACCIAVITI

SET CACCIAVITI

BGS articolo
BGS 9151

DESCRIZIONE
SET 6 PEZZI, MINI CACCIAVITI CON TESTA GIREVOLE, PH E TAGLIO

- CARATTERISTICHE**
- misure:
 - cacciaviti Taglio lunghezza 75 mm: 2 - 3 - 4 mm
 - cacciaviti PH lunghezza 75 mm: PH 00, PH 0, PH 1
 - punte con rivestimento al fosfato
 - lame al cromo vanadio, satinare cromate
 - impugnature in materiale bi-componente
 - peso 300 g

BGS articolo
BGS 35807

DESCRIZIONE
SET 6 PEZZI, MINI CACCIAVITI CON TESTA GIREVOLE, PH E TAGLIO

- CARATTERISTICHE**
- comprende le seguenti misure:
 - Taglio: 0.3 x 1.4 x 50 mm - 0.4 x 2.0 x 50 mm - 0.4 x 2.5 x 50 mm
 - PH: PH00 x 50 mm - PH0 x 50 mm - PH1 x 50 mm
 - impugnature in materiale bi-componente
 - lame in acciaio chrome vanadium
 - lame satinare con punte con finitura nera
 - in custodia rigida
 - peso 200 g

BGS articolo
BGS 8833

DESCRIZIONE
SET 12 PEZZI, CACCIAVITI DI PRECISIONE E GANCI

- CARATTERISTICHE**
- comprende:
 - 2 cacciaviti Taglio: 2.5 mm - 3.5 mm
 - 2 cacciaviti Phillips: PH0 - PH00
 - 4 cacciaviti Torx: TX6 - TX7 - TX8 - TX10
 - 4 Ganci: 45° - 90° - 135° - 180°
 - impugnatura in materiale bi-componente
 - lunghezza: circa 170 mm
 - peso 350 g

BGS articolo
BGS 7968

DESCRIZIONE
SET 6 PEZZI, CACCIAVITI DI PRECISIONE

- CARATTERISTICHE**
- comprende:
 - Taglio: 1,4 - 2,0 - 2,4 - 3,0
 - PH: 0 - 1
 - nichelati
 - in custodia di plastica
 - peso 350 g

BGS articolo
BGS 7969

DESCRIZIONE
SET 11 PEZZI, CACCIAVITI DI PRECISIONE

- CARATTERISTICHE**
- comprende:
 - Taglio: 1,0 - 1,2 - 1,4 - 1,8 - 2,4 - 3,0
 - PH: 00 - 0 - 1
 - punteruolo
 - supporto magnetico
 - temperate
 - in custodia di plastica
 - peso 120 g

BGS articolo
BGS 797

DESCRIZIONE
SET 7 PEZZI, CACCIAVITI DI PRECISIONE

- CARATTERISTICHE**
- con 7 inserti di precisione intercambiabili a doppia estremità
 - comprende:
 - Torx: TX6xTX10 - TX7xTX15 - TX8xTX20 - TX9xTX15
 - PH 00 x Taglio 2 mm
 - PH 0 x Taglio 3 mm
 - PH 1 x Taglio 4 mm
 - porta-inserti
 - in custodia di plastica con coperchio trasparente
 - peso 250 g

RICAMBI

BGS articolo
BGS 797-LEER

DESCRIZIONE
CASSETTA VUOTA

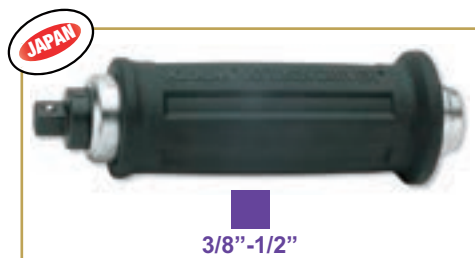

3/8"-1/2"

**CACCIAVITE A PERCUSSIONE AD ALTA RESISTENZA
IMPUGNATURA RIVESTITA IN GOMMA**

attacco: 3/8" - 1/2"

| Koken articolo | 3/8" | L mm |  |
|----------------|------|------|---|
| 3112 G | 3/8" | 159 | 1 |
| 4112 G | 1/2" | 163 | 1 |



1/2"  

- 1 CACCIAVITE A PERCUSSIONE 1/2"
- 1 BUSSOLA PORTAINSERI 5/16"
- 2 INSERTI PH 2-3
- 2 INSERTI TAGLIO 9-11

attacco: 1/2"

| Koken articolo | Descrizione |  |
|----------------|----------------------------|---|
| AG 112 A | CASSETTA METALLICA 6 PEZZI | 1 |



1/2"   

- 1 CACCIAVITE A PERCUSSIONE 1/2"
- 1 BUSSOLA PORTAINSERI 5/16"
- 3 INSERTI PH 2-3-4
- 5 INSERTI A TAGLIO 8-9-10-12-14 MM
- 4 INSERTI ESAGONO BRUGOLA 5-6-8-10 MM
- 4 INSERTI TORX® TX 30-40-45-50

attacco: 1/2"

| Koken articolo | Descrizione |  |
|----------------|-----------------------------|---|
| AG 112 H | CASSETTA METALLICA 18 PEZZI | 1 |

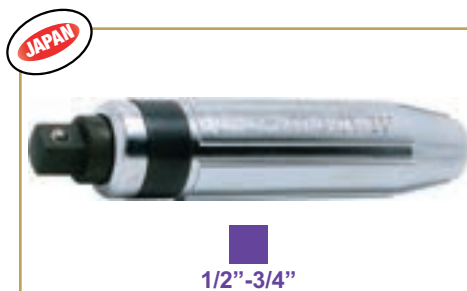

1/2"-3/4"

CACCIAVITE A PERCUSSIONE AD ALTA RESISTENZA

attacco: 1/2" - 3/4"

| Koken articolo | 1/2" | L mm |  |
|----------------|------|------|---|
| 4112 N | 1/2" | 163 | 1 |
| 6112 | 3/4" | 190 | 1 |



1/2"  

- 1 CACCIAVITE A PERCUSSIONE 1/2"
- 1 BUSSOLA PORTAINSERI 5/16"
- 2 INSERTI PH 2-3 L. 32 MM
- 2 INSERTI TAGLIO 9-11 L. 32 MM

attacco: 1/2"

| Koken articolo | Descrizione |  |
|----------------|----------------------------|---|
| AN 112 A | CASSETTA METALLICA 6 PEZZI | 1 |



1/2"  

- 1 CACCIAVITE A PERCUSSIONE 1/2"
- 1 BUSSOLA PORTAINSERI 5/16"
- 3 INSERTI PH 1-2-3 L. 80 MM
- 3 INSERTI TAGLIO 7-9-12 L. 80 MM

attacco: 1/2"

| Koken articolo | Descrizione |  |
|----------------|----------------------------|---|
| AN 112 C | CASSETTA METALLICA 8 PEZZI | 1 |



   ESAGONO 5/16" C

| BGS articolo | DESCRIZIONE |
|--------------|--------------------------|
| BGS 712 | CACCIAVITE A PERCUSSIONE |

CARATTERISTICHE

- per allentare viti bloccate
- impugnatura con protezione per mano
- comprende:
 - cacciavite a percussione, att. quadro 1/2"
 - adattatore portainseri
 - inserti Taglio: 5 - 6 - 8 - 9 mm
 - inserti PH: 1 - 2 - 3 - 4
 - inserti Esagonali: 4 - 5 - 6 - 8 mm
- peso: 900 g



1/2"  PRO+  ESAGONO 5/16" C

| BGS articolo | DESCRIZIONE |
|--------------|--|
| BGS 710 | SET 5 PEZZI, CACCIAVITE A PERCUSSIONE, ATT. 1/2" |

CARATTERISTICHE

- alta qualità
- finitura satinata cromata
- con 4 inserti:
 - Taglio: 8 - 10 mm
 - PH: 2 - 3
- in cassetta metallica
- peso 1,0 kg

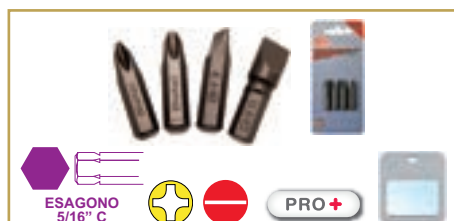

 ESAGONO 5/16" C   PRO+

| BGS articolo | DESCRIZIONE |
|--------------|-----------------------------|
| BGS 711 | SET 4 INSERTI ATTACCO 5/16" |

CARATTERISTICHE

- attacco esagonale da 5/16 mm, lunghezza 36 mm
- 2 inserti Taglio 8 - 10 mm
- 2 inserti PH: 2 - 3
- peso 60 g

NUOVA
PRODUZIONE



ESAGONO

CHIAVE A BUSSOLA ESAGONALE CON
IMPUGNATURA ESAGONALE

| FEFMEC articolo | mm | L mm | |
|--------------------|-----|------|---|
| 440-3 | 3 | 125 | 1 |
| 440-3,5 | 3,5 | 125 | 1 |
| 440-4 | 4 | 125 | 1 |
| 440-4,5 | 4,5 | 125 | 1 |
| 440-5 | 5 | 125 | 1 |
| 440-5,5 | 5,5 | 125 | 1 |
| 440-6 | 6 | 125 | 1 |
| 440-7 | 7 | 125 | 1 |
| 440-8 | 8 | 125 | 1 |
| 440-9 | 9 | 125 | 1 |
| 440-10 | 10 | 125 | 1 |
| 440-11 | 11 | 125 | 1 |
| 440-12 | 12 | 125 | 1 |
| 440-13 | 13 | 125 | 1 |
| 440-14 | 14 | 125 | 1 |
| 440-15 | 15 | 125 | 1 |
| 440-16 | 16 | 125 | 1 |
| 440-17 | 17 | 125 | 1 |

FLEX



ESAGONO

CHIAVE A BUSSOLA ESAGONALE CON
IMPUGNATURA, FLESSIBILE

| FEFMEC articolo | mm | L mm | |
|--------------------|----|------|---|
| 420-0006 | 6 | 150 | 1 |
| 420-0007 | 7 | 150 | 1 |
| 420-0008 | 8 | 150 | 1 |
| 420-0010 | 10 | 175 | 1 |

FLEX



ESAGONO

IMPUGNATURA ESAGONALE FLESSIBILE,
LUNGHEZZA TOTALE 300 MM

| BGS articolo | mm | L mm |
|-----------------|----|------|
| BGS 7826 | 6 | 175 |
| BGS 7827 | 7 | 175 |
| BGS 7828 | 8 | 175 |

CARATTERISTICHE

- bussola esagonale

NEW



ESAGONO



CHIAVI A BUSSOLA ESAGONALE
CON IMPUGNATURA, ISOLATE VDE

| FEFMEC articolo | mm | |
|--------------------|-----|---|
| FM 345-5,5 | 5,5 | 1 |
| FM 345-6 | 6 | 1 |
| FM 345-7 | 7 | 1 |
| FM 345-8 | 8 | 1 |
| FM 345-10 | 10 | 1 |
| FM 345-13 | 13 | 1 |

JAPAN



**NUT GRIP®
BLOCCADADI**

IMPUGNATURA
CON LAMA
INTERCAMBIABILE
IMPRONTA
BLOCCADADI
NUT GRIP

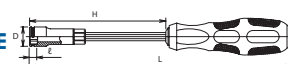

| Koken articolo | mm | D mm | H mm | L mm | | Euro |
|-------------------|----|------|------|------|---|------|
| 167C-7(2B) | 7 | 11.5 | 122 | 235 | 1 | |
| 167C-8(2B) | 8 | 12.3 | 122 | 235 | 1 | |
| 167C-10(2B) | 10 | 14.2 | 122 | 235 | 1 | |
| 167C-12(2B) | 12 | 17.3 | 122 | 235 | 1 | |

| | | |
|-----------|---|---|
| 167C/3-2B | Set 3 lame (7, 8, 10 mm) + impugnatura in cassetta plastica | 1 |
|-----------|---|---|



ESAGONO

CHIAVE A BUSSOLA ESAGONALE CROMATA
LUCIDA CON IMPUGNATURA

| Koken articolo | mm | L mm | |
|-------------------|-----|------|---|
| 167 M-3 | 3 | 125 | 1 |
| 167 M-3,5 | 3,5 | 125 | 1 |
| 167 M-4 | 4 | 125 | 1 |
| 167 M-4,5 | 4,5 | 125 | 1 |
| 167 M-5 | 5 | 125 | 1 |
| 167 M-5,5 | 5,5 | 125 | 1 |
| 167 M-6 | 6 | 125 | 1 |
| 167 M-7 | 7 | 125 | 1 |
| 167 M-8 | 8 | 125 | 1 |
| 167 M-9 | 9 | 125 | 1 |
| 167 M-10 | 10 | 125 | 1 |
| 167 M-11 | 11 | 125 | 1 |
| 167 M-12 | 12 | 125 | 1 |
| 167 M-13 | 13 | 125 | 1 |
| 167 M-14 | 14 | 125 | 1 |

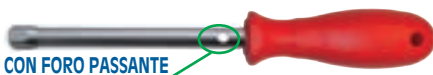

CON FORO PASSANTE

ESAGONO

CHIAVE A TUBO ESAGONALE VUOTA
CON IMPUGNATURA E FORO
MADE IN GERMANY

| FEFMEC articolo | mm | L mm | |
|--------------------|-----|------|---|
| 4655 | 5,5 | 120 | 1 |
| 4606 | 6 | 120 | 1 |
| 4607 | 7 | 120 | 1 |
| 4608 | 8 | 120 | 1 |
| 4609 | 9 | 120 | 1 |
| 4610 | 10 | 120 | 1 |
| 4611 | 11 | 120 | 1 |
| 4612 | 12 | 120 | 1 |
| 4613 | 13 | 120 | 1 |



4 CHIAVI A TUBO E CON IMPUGNATURA

CHIAVI A BUSSOLA CON IMPUGNATURA

POLLICI



ESAGONO

SET 12 CHIAVI A BUSSOLA ESAGONALI CON IMPUGNATURA 5/32"; 3/16"; 7/32"; 1/4"; 9/32"; 5/16"; 11/32"; 3/8"; 7/16"; 1/2"; 9/16"; 5/8"

| articolo | pollici | L mm | |
|--------------|---------|------|---|
| 44580 | | 130 | 1 |
| RICAMBI | | | |
| 44580-5/32" | 5/32" | 130 | 1 |
| 44580-3/16" | 3/16" | 130 | 1 |
| 44580-7/32" | 7/32" | 130 | 1 |
| 44580-1/4" | 1/4" | 130 | 1 |
| 44580-9/32" | 9/32" | 130 | 1 |
| 44580-5/16" | 5/16" | 130 | 1 |
| 44580-11/32" | 11/32" | 130 | 1 |
| 44580-3/8" | 3/8" | 130 | 1 |
| 44580-7/16" | 7/16" | 130 | 1 |
| 44580-1/2" | 1/2" | 130 | 1 |
| 44580-9/16" | 9/16" | 130 | 1 |
| 44580-5/8" | 5/8" | 130 | 1 |



ESAGONO

PRO+

BGS
articolo

DESCRIZIONE

BGS 1218

SET 8 PEZZI,
CHIAVI A TUBO
DOPPIE,
6X7-20X22 MM

CARATTERISTICHE

- forgiate
- finitura satinata cromata
- misure: 6x7 - 8x9 - 10x11 - 12x13 - 14x15 - 16x17 - 18x19 - 20x22 mm
- in custodia
- peso 920 g

Spezial-Schlüssel
8 in 1
12-13-14-15-16-17-18-19 mm



ESAGONO



CV

BGS
articolo

DESCRIZIONE

BGS 7075

CHIAVE SPECIALE
8 IN 1, 12 - 19 MM

CARATTERISTICHE

- misure: 12-13-14-15-16-17-18-19 mm
- materiale: Acciaio Chrome Vanadium
- peso 540 g



ESAGONO



BGS
articolo

DESCRIZIONE

BGS 85814

SET 6 PEZZI,
CHIAVI A TUBO
DOPPIE,
8X9 - 16X17 MM

CARATTERISTICHE

- misure: 8x9 - 10x11 - 12x13 - 14x15 - 16x17 mm
- finitura cromata
- comprende barra di manovra
- serie economica
- peso 380 g

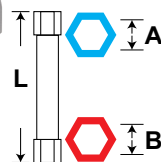

ESAGONO

CHIAVE A TUBO ESAGONALE DOPPIA
SERIE LEGGERA
DIN 896

| articolo | A mm | B mm | L mm | |
|-----------|------|------|------|---|
| 896-6X7 | 6 | 7 | 100 | 1 |
| 896-8X9 | 8 | 9 | 100 | 1 |
| 896-10X11 | 10 | 11 | 120 | 1 |
| 896-12X13 | 12 | 13 | 140 | 1 |
| 896-14X15 | 14 | 15 | 140 | 1 |
| 896-16X17 | 16 | 17 | 150 | 1 |
| 896-17X19 | 17 | 19 | 160 | 1 |
| 896-18X19 | 18 | 19 | 160 | 1 |
| 896-20X22 | 20 | 22 | 160 | 1 |
| 896-21X23 | 21 | 23 | 185 | 1 |
| 896-24X27 | 24 | 27 | 185 | 1 |
| 896-30X32 | 30 | 32 | 220 | 1 |
| 896-36X41 | 36 | 41 | 220 | 1 |
| 896-41X46 | 41 | 46 | 237 | 1 |



POLIGONALE

PRO+

CV

BGS
articolo

DESCRIZIONE

BGS 1201

SET 6 PEZZI,
CHIAVI A DOPPIA
BUSSOLA CON TESTE
SNODATE

CARATTERISTICHE

- bussole poligonali
- misure: 8x9 - 10x11 - 12x13 - 14x15 - 16x17 - 18x19 mm
- in custodia
- peso 1,3 kg



CHIAVI A BUSSOLA ESAGONALI CON IMPUGNATURA A "T"

| Kokon articolo | mm | L mm | |
|----------------|----|------|---|
| 104 ME-6 | 6 | 200 | 1 |
| 104 ME-7 | 7 | 200 | 1 |
| 104 ME-8 | 8 | 250 | 1 |
| 104 ME-9 | 9 | 250 | 1 |
| 104 ME-10 | 10 | 250 | 1 |
| 104 ME-11 | 11 | 250 | 1 |
| 104 ME-12 | 12 | 250 | 1 |
| 104 ME-13 | 13 | 250 | 1 |
| 104 ME-14 | 14 | 250 | 1 |
| 104 ME-15 | 15 | 250 | 1 |
| 104 ME-16 | 16 | 250 | 1 |
| 104 ME-17 | 17 | 250 | 1 |
| 104 ME-18 | 18 | 250 | 1 |
| 104 ME-19 | 19 | 250 | 1 |

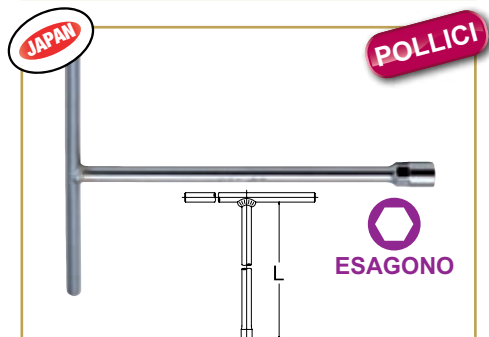

CHIAVI A BUSSOLA ESAGONALI CON IMPUGNATURA A "T"

| Kokon articolo | mm | L mm | |
|----------------|-------|------|---|
| 104 A-1/4" | 1/4" | 200 | 1 |
| 104 A-5/16" | 5/16" | 250 | 1 |
| 104 A-3/8" | 3/8" | 250 | 1 |
| 104 A-7/16" | 7/16" | 250 | 1 |
| 104 A-1/2" | 1/2" | 300 | 1 |
| 104 A-9/16" | 9/16" | 300 | 1 |
| 104 A-5/8" | 5/8" | 350 | 1 |
| 104 A-3/4" | 3/4" | 350 | 1 |



CHIAVI A BUSSOLA ESAGONALE CON IMPUGNATURA A "T" E SCARICO MAGGIORATO 35/50 MM

| FE#MEC articolo | mm | scarico "A" mm | L mm | |
|-----------------|----|----------------|------|---|
| 410-0600 | 6 | 35 | 230 | 1 |
| 410-0700 | 7 | 35 | 230 | 1 |
| 410-0800 | 8 | 35 | 230 | 1 |
| 410-0900 | 9 | 50 | 230 | 1 |
| 410-1000 | 10 | 50 | 230 | 1 |
| 410-1100 | 11 | 50 | 230 | 1 |
| 410-1200 | 12 | 50 | 230 | 1 |
| 410-1300 | 13 | 50 | 230 | 1 |
| 410-1400 | 14 | 50 | 230 | 1 |

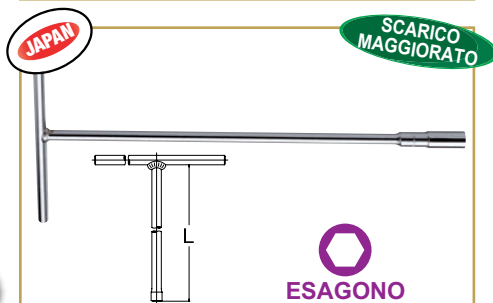

CHIAVI A BUSSOLA ESAGONALI CON IMPUGNATURA A "T"

| Kokon articolo | mm | L mm | |
|----------------|----|------|---|
| 156 M-8 | 8 | 355 | 1 |
| 156 M-10 | 10 | 355 | 1 |
| 156 M-12 | 12 | 355 | 1 |
| 156 M-14 | 14 | 355 | 1 |



CHIAVI A BUSSOLA ESAGONALE CON IMPUGNATURA A "T"

| FE#MEC articolo | mm | L mm | |
|-----------------|-------|------|---|
| 400-6-230 | 6 | 230 | 1 |
| 400-7-230 | 7 | 230 | 1 |
| 400-7-350 | 7 | 350 | 1 |
| 400-8-230 | 8 | 230 | 1 |
| 400-8-350 | 8 | 350 | 1 |
| 400-9-230 | 9 | 230 | 1 |
| 400-9-350 | 9 | 350 | 1 |
| 400-10-230 | 10 | 230 | 1 |
| 400-10-350 | 10 | 350 | 1 |
| 400-11-230 | 11 | 230 | 1 |
| 400-11-350 | 11 | 350 | 1 |
| 400-12-230 | 12 | 230 | 1 |
| 400-12-350 | 12 | 350 | 1 |
| 400-13-230 | 13 | 230 | 1 |
| 400-13-350 | 13 | 350 | 1 |
| 400-14-230 | 14 | 230 | 1 |
| 400-14-350 | 14 | 350 | 1 |
| 400-17-230 | 17 | 230 | 1 |
| 400-17-350 | 17 | 350 | 1 |
| 405-8-230 M | 8 | 230 | 1 |
| 405-10-230 M | 10 | 230 | 1 |
| 405-13-230 M | 13 | 230 | 1 |
| 400-1/4"-230 | 1/4" | 230 | 1 |
| 400-5/16"-230 | 5/16" | 230 | 1 |
| 400-3/8"-230 | 3/8" | 230 | 1 |
| 400-7/16"-230 | 7/16" | 230 | 1 |
| 400-1/2"-230 | 1/2" | 230 | 1 |
| 400-9/16"-230 | 9/16" | 230 | 1 |

POLLICI

CHIAVI A BUSSOLA CON IMPUGNATURA

4 CHIAVI A BUSSOLA CON IMPUGNATURA

CHIAVI A BUSSOLA CON IMPUGNATURA

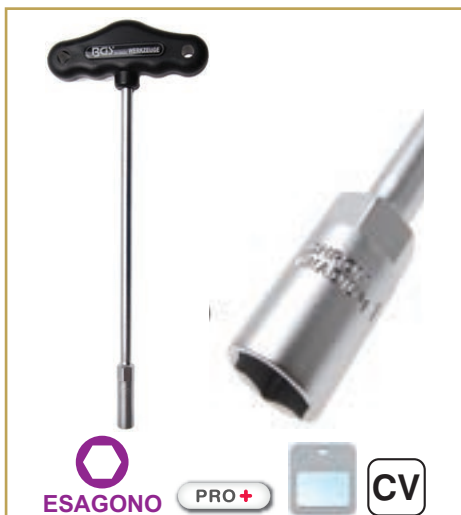

CHIAVI A BUSSOLA ESAGONALE CON IMPUGNATURA A "T"
IMPUGNATURE ULTRA-PESANTI IN PLASTICA CON FORO ESAGONO ESTERNO PER VITI DIFFICILI DA ALLENTARE

| BGS articolo | mm | L mm | |
|--------------|----|------|---|
| BGS 7806 | 6 | 230 | 1 |
| BGS 7807 | 7 | 230 | 1 |
| BGS 7808 | 8 | 230 | 1 |
| BGS 7809 | 9 | 230 | 1 |
| BGS 7810 | 10 | 230 | 1 |
| BGS 7811 | 11 | 230 | 1 |
| BGS 7812 | 12 | 230 | 1 |
| BGS 7813 | 13 | 230 | 1 |
| BGS 7814 | 14 | 230 | 1 |



CHIAVI A BUSSOLA ESAGONALE CON IMPUGNATURA A "T"

| BGS articolo | mm | L mm |
|--------------|----|------|
| BGS 8994 | 8 | 430 |
| BGS 8995 | 10 | 430 |
| BGS 8996 | 13 | 430 |

CARATTERISTICHE

- impugnatura a T
- finitura satinata cromata



ESAGONO   

| BGS articolo | DESCRIZIONE |
|--------------|---|
| BGS 7881 | SET 9 PEZZI, CHIAVI A BUSSOLA ESAGONALI, CON IMPUGNATURA A T, 6-14 MM |

CARATTERISTICHE

- misure: 6 - 7 - 8 - 9 - 10 - 11 - 12 - 13 - 14 mm
- lunghezza stelo: circa 270 mm
- impugnature in materiale bi-componente
- materiale: Acciaio Chrome Vanadium
- peso 2,7 kg



CHIAVI A "T" BOCCA ESAGONALE SNODATE EXTRA LUNGHE BRUNITE CON ASTA SCORREVOLE

| Koken articolo | mm | L mm | |
|----------------|----|------|---|
| 3116 M-10 | 10 | 800 | 1 |
| 3116 M-12 | 12 | 800 | 1 |
| 3116 M-13 | 13 | 800 | 1 |
| 3116 M-14 | 14 | 800 | 1 |
| 3116 M-15 | 15 | 800 | 1 |
| 3116 M-16 | 16 | 800 | 1 |
| 3116 M-17 | 17 | 800 | 1 |
| 3116 M-18 | 18 | 800 | 1 |



**NUT GRIP®
BLOCCADADI**

**CHIAVI A "T" BOCCA ESAGONALE SNODATE
CON SISTEMA BLOCCA DADI**

| Kokon articolo | mm | L mm | |
|--------------------------|----|---------|---|
| 124 M-8 | 8 | 600 | 1 |
| 124 M-10 | 10 | 600 | 1 |
| 124 M-12 | 12 | 600 | 1 |
| 124 M-13 | 13 | 600 | 1 |
| 124 M-14 | 14 | 600 | 1 |
| 124 M-17 | 17 | 600 | 1 |

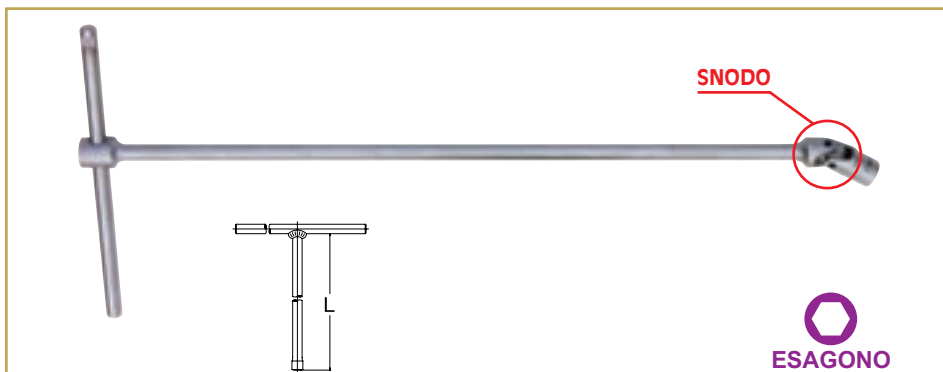

**CHIAVI A "T" BOCCA ESAGONALE SNODATE CROMATE ASTA SCORREVOLE
CHROM-VANADIUM**

| FERMEC articolo | mm | L mm | |
|---------------------------|----|---------|---|
| 580-7 | 7 | 400 | 1 |
| 580-8 | 8 | 400 | 1 |
| 580-9 | 9 | 400 | 1 |
| 580-10 | 10 | 500 | 1 |
| 580-11 | 11 | 500 | 1 |
| 580-12 | 12 | 500 | 1 |
| 580-13 | 13 | 500 | 1 |
| 580-14 | 14 | 500 | 1 |
| 580-15 | 15 | 500 | 1 |
| 580-16 | 16 | 500 | 1 |
| 580-17 | 17 | 500 | 1 |
| 580-18 | 18 | 500 | 1 |
| 580-19 | 19 | 500 | 1 |



ESAGONO



| BGS articolo | DESCRIZIONE |
|------------------------|---|
| BGS 1178 | SET 11 PEZZI, CHIAVI A PIPA, 6-22 MM |

CARATTERISTICHE

- entrambe le estremità con bussole esagonali
- per ciascuna misura è presente un'estremità dritta e una sfasata
- misure: 6-7-8-10-11-12-13-14-17-19-22 mm
- peso 3,0 kg



**CHIAVI A PIPA PASSANTI ESAGONALI
TIPO PESANTE**

CROMATE LUCIDE

| FERMEC articolo | mm | L mm | |
|---------------------------|----|---------|---|
| 4619-6 | 6 | 100 | 1 |
| 4619-7 | 7 | 110 | 1 |
| 4619-8 | 8 | 120 | 1 |
| 4619-10 | 10 | 130 | 1 |
| 4619-11 | 11 | 135 | 1 |
| 4619-12 | 12 | 140 | 1 |
| 4619-13 | 13 | 150 | 1 |
| 4619-14 | 14 | 160 | 1 |
| 4619-17 | 17 | 180 | 1 |
| 4619-19 | 19 | 200 | 1 |
| 4619-22 | 22 | 240 | 1 |
| 4619-25 | 25 | 260 | 1 |



Esagonali con foro



ESAGONO CON FORO

CHIAVI ESAGONALI TCCE CON FORO ZINCATE PIEGATE

| FEFMEC articolo | mm | L mm |  |
|-----------------|-----|----------|---|
| 911-CV-2,5 | 2,5 | 56 X 18 | 1 |
| 911-CV-3 | 3 | 63 X 20 | 1 |
| 911-CV-4 | 4 | 71 X 25 | 1 |
| 911-CV-5 | 5 | 80 X 28 | 1 |
| 911-CV-6 | 6 | 90 X 32 | 1 |
| 911-CV-8 | 8 | 100 X 36 | 1 |



SERIE 6 CHIAVI ESAGONALI TCCE C/FORO PIEGATE

| FEFMEC articolo | mm |  |
|-----------------|-------------------------|---|
| 911-CV-258 | 2,5 - 3 - 4 - 5 - 6 - 8 | 1 |

Esagonali con perno di centraggio



ESAGONO CON PERNO DI CENTRAGGIO

CHIAVI ESAGONALI TCCE CON PERNO DI CENTRAGGIO ZINCATE

| FEFMEC articolo | mm | L mm |  |
|-----------------|--|-----------|---|
| 6911-CV-3C | 3 | 63 X 20 | 1 |
| 6911-CV-4C | 4 | 71 X 25 | 1 |
| 6911-CV-5C | 5 | 80 X 28 | 1 |
| 6911-CV-6C | 6 | 90 X 32 | 1 |
| 6911-CV-8C | 8 | 100 X 36 | 1 |
| 6911-CV-10C | 10 | 112 X 40 | 1 |
| 6911-CV-12C | 12 | 125 X 45 | 1 |
| 6911-CV-14C | 14 | 140 X 55 | 1 |
| 6911-CV-17C | 17 | 160 X 60 | 1 |
| 6911-CV-19C | 19 | 180 X 70 | 1 |
| 6911-CV-22C | 22 | 200 X 80 | 1 |
| 6911-CV-24C | 24 | 224 X 90 | 1 |
| 6911-CV-27C | 27 | 250 X 100 | 1 |
| 6911-T-310 | SERIE 6 PEZZI 3 - 4 - 5 6 - 8 - 10 | | 1 |

Esagonali

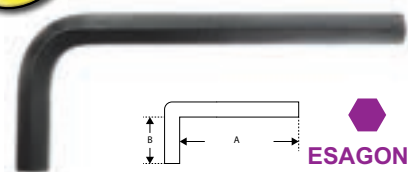

ESAGONO

CHIAVI MASCHIO ESAGONALI PIEGATE BRUNITE - ACCIAIO TEMPRATO

| FEFMEC articolo | mm | A x B mm |  |
|-----------------|------|-----------|---|
| 911-0,7 | 0,7 | 32 X 8 | 1 |
| 911-0,9 | 0,9 | 32 X 10 | 1 |
| 911-1 | 1 | 32 X 10 | 1 |
| 911-1,19 | 1,19 | 40 X 12 | 1 |
| 911-1,27 | 1,27 | 45 X 14 | 1 |
| 911-1,5 | 1,5 | 45 X 14 | 1 |
| 911-2 | 2 | 50 X 16 | 1 |
| 911-2,5 | 2,5 | 56 X 18 | 1 |
| 911-2,77 | 2,77 | 56 X 18 | 1 |
| 911-3 | 3 | 63 X 20 | 1 |
| 911-3,5 | 3,5 | 66 X 22 | 1 |
| 911-4 | 4 | 70 X 25 | 1 |
| 911-4,5 | 4,5 | 75 X 26 | 1 |
| 911-5 | 5 | 80 X 28 | 1 |
| 911-5,5 | 5,5 | 85 X 30 | 1 |
| 911-6 | 6 | 90 X 32 | 1 |
| 911-6,5 | 6,5 | 92 X 33 | 1 |
| 911-7 | 7 | 95 X 34 | 1 |
| 911-8 | 8 | 100 X 36 | 1 |
| 911-9 | 9 | 105 X 38 | 1 |
| 911-10 | 10 | 112 X 40 | 1 |
| 911-11 | 11 | 118 X 42 | 1 |
| 911-12 | 12 | 125 X 45 | 1 |
| 911-13 | 13 | 132 X 50 | 1 |
| 911-14 | 14 | 140 X 56 | 1 |
| 911-15 | 15 | 146 X 58 | 1 |
| 911-16 | 16 | 152 X 60 | 1 |
| 911-17 | 17 | 160 X 63 | 1 |
| 911-18 | 18 | 170 X 65 | 1 |
| 911-19 | 19 | 180 X 70 | 1 |
| 911-20 | 20 | 180 X 70 | 1 |
| 911-21 | 21 | 190 X 75 | 1 |
| 911-22 | 22 | 200 X 80 | 1 |
| 911-24 | 24 | 224 X 90 | 1 |
| 911-27 | 27 | 250 X 100 | 1 |
| 911-30 | 30 | 285 X 112 | 1 |
| 911-32 | 32 | 315 X 125 | 1 |
| 911-36 | 36 | 355 X 140 | 1 |
| 911-41 | 41 | 401 X 153 | 1 |
| 911-42 | 42 | 407 X 157 | 1 |
| 911-46 | 46 | 444 X 166 | 1 |
| 911-50 | 50 | 474 X 184 | 1 |
| 911-55 | 55 | 520 X 194 | 1 |
| 911-60 | 60 | 564 X 208 | 1 |
| 911-65 | 65 | 589 X 223 | 1 |

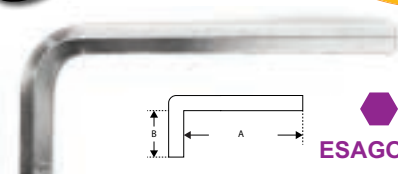

SATINATE

ESAGONO

CHIAVI MASCHIO ESAGONALI PIEGATE SATINATE - ACCIAIO TEMPRATO

| FEFMEC articolo | mm | A x B mm |  |
|-----------------|-----|-----------|---|
| 911-1,5 C | 1,5 | 45 X 14 | 1 |
| 911-2 C | 2 | 50 X 16 | 1 |
| 911-2,5 C | 2,5 | 56 X 18 | 1 |
| 911-3 C | 3 | 63 X 20 | 1 |
| 911-3,5 C | 3,5 | 66 X 22 | 1 |
| 911-4 C | 4 | 70 X 25 | 1 |
| 911-4,5 C | 4,5 | 75 X 26 | 1 |
| 911-5 C | 5 | 80 X 28 | 1 |
| 911-5,5 C | 5,5 | 85 X 30 | 1 |
| 911-6 C | 6 | 90 X 32 | 1 |
| 911-6,5 C | 6,5 | 92 X 33 | 1 |
| 911-7 C | 7 | 95 X 34 | 1 |
| 911-8 C | 8 | 100 X 36 | 1 |
| 911-9 C | 9 | 105 X 38 | 1 |
| 911-10 C | 10 | 112 X 40 | 1 |
| 911-11 C | 11 | 118 X 42 | 1 |
| 911-12 C | 12 | 125 X 45 | 1 |
| 911-13 C | 13 | 132 X 50 | 1 |
| 911-14 C | 14 | 140 X 56 | 1 |
| 911-15 C | 15 | 146 X 58 | 1 |
| 911-16 C | 16 | 152 X 60 | 1 |
| 911-17 C | 17 | 160 X 63 | 1 |
| 911-18 C | 18 | 170 X 65 | 1 |
| 911-19 C | 19 | 180 X 70 | 1 |
| 911-20 C | 20 | 180 X 70 | 1 |
| 911-21 C | 21 | 190 X 75 | 1 |
| 911-22 C | 22 | 200 X 80 | 1 |
| 911-24 C | 24 | 224 X 90 | 1 |
| 911-27 C | 27 | 250 X 100 | 1 |
| 911-30 C | 30 | 285 X 112 | 1 |
| 911-32 C | 32 | 315 X 125 | 1 |
| 911-36 C | 36 | 355 X 140 | 1 |



ESAGONO

SERIE 9 CHIAVI ESAGONALI TCCE SATINATE

| | | |
|--------------------|---|---|
| | | |
| articolo | mm | |
| 911-WS-110C | 1,5 - 2 - 2,5 - 3 - 4 5 - 6 - 8 - 10 | 1 |

ESAGONO

SERIE 9 CHIAVI ESAGONALI TCCE BRUNITE

| | | |
|---------------------|------------------------------|---|
| | | |
| articolo | mm | |
| 911-110-CLIP | 1,5-2-2,5-3-4-5-6 8-10 mm | 1 |

ESAGONO

OGNI MISURA UN COLORE

SERIE 9 CHIAVI ESAGONALI TCCE COLORATE

| | | |
|------------------|------------------------------|---|
| | | |
| articolo | mm | |
| 911-COLOR | 1,5-2-2,5-3-4-5-6 8-10 mm | 1 |

ESAGONO **PRO+** **CV**

| | |
|----------------|---|
| | DESCRIZIONE |
| articolo | SERIE 9 PEZZI, CHIAVI MASCHIO ESAGONALI PIEGATE, 1,5-10 MM |
| BGS 807 | |

| |
|--|
| CARATTERISTICHE |
| <ul style="list-style-type: none"> • satinata • tipo corto • in supporto pieghevole • materiale: Acciaio Chrome Vanadium • peso 290 g |

ESAGONO **CV**

| | |
|-----------------|---|
| | DESCRIZIONE |
| articolo | SERIE 9 PEZZI, CHIAVI MASCHIO ESAGONALI PIEGATE, 1,5-10 MM |
| BGS 7957 | |

| |
|---|
| CARATTERISTICHE |
| <ul style="list-style-type: none"> • dimensioni: 1,5 - 2 - 2,5 - 3 - 4 - 5 - 6 - 8 - 10 mm • finitura nera • in cassetta di plastica • materiale: Acciaio Chrome Vanadium • peso 300 g |

XXL

LUNGHEZZA 600 MM

ESAGONO

SERIE 6 CHIAVI ESAGONALI SATINATE TIPO EXTRA LUNGO
LUNGHEZZA: 600 MM

| | | |
|--------------|--------------|---|
| | | |
| articolo | mm | |
| 91600 | 4-5-6-7-8-10 | 1 |

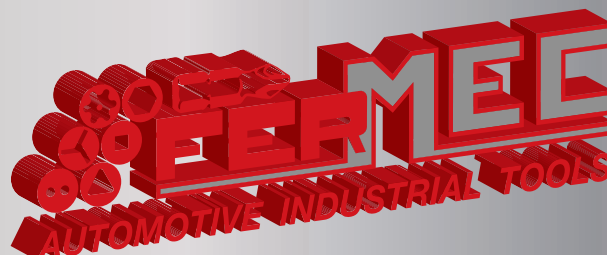

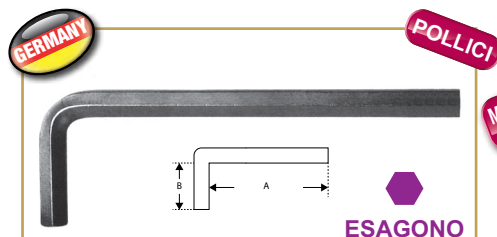

ESAGONO

**CHIAVI MASCHIO ESAGONALI PIEGATE
BRUNITE IN POLLICI**

| FEFMEC articolo | ESAGONO pollici | A x B mm | |
|--------------------|--------------------|-------------|---|
| 911-0/028" | 0/028" | 30 X 10 | 1 |
| 911-0/035" | 0/035" | 32 X 10 | 1 |
| 911-3/64" | 3/64" | 40 X 12 | 1 |
| 911-0/050" | 0/050" | 45 X 14 | 1 |
| 911-1/16" | 1/16" | 45 X 14 | 1 |
| 911-5/64" | 5/64" | 50 X 16 | 1 |
| 911-3/32" | 3/32" | 56 X 18 | 1 |
| 911-7/64" | 7/64" | 56 X 18 | 1 |
| 911-1/8" | 1/8" | 63 X 20 | 1 |
| 911-9/64" | 9/64" | 68 X 22 | 1 |
| 911-5/32" | 5/32" | 71 X 25 | 1 |
| 911-3/16" | 3/16" | 80 X 28 | 1 |
| 911-7/32" | 7/32" | 80 X 32 | 1 |
| 911-1/4" | 1/4" | 90 X 32 | 1 |
| 911-9/32" | 9/32" | 95 X 34 | 1 |
| 911-5/16" | 5/16" | 100 X 36 | 1 |
| 911-11/32" | 11/32" | 105 X 38 | 1 |
| 911-3/8" | 3/8" | 112 X 40 | 1 |
| 911-7/16" | 7/16" | 118 X 42 | 1 |
| 911-1/2" | 1/2" | 132 X 50 | 1 |
| 911-9/16" | 9/16" | 140 X 55 | 1 |
| 911-5/8" | 5/8" | 145 X 58 | 1 |
| 911-3/4" | 3/4" | 180 X 70 | 1 |
| 911-7/8" | 7/8" | 200 X 80 | 1 |
| 911-100" | 1" | 250 X 100 | 1 |



**SERIE 9 CHIAVI ESAGONALI TCCE MISURE
IN POLLICI BRUNITE**

| FEFMEC articolo | ESAGONO | |
|--------------------|--|---|
| 911-138-CLIP | 1/16" - 5/64" - 3/32" 1/8" - 5/32" - 3/16" 1/4" - 5/16" - 3/8" | 1 |



**SERIE 30 CHIAVI ESAGONALI TCCE CON
UNA ESTREMITÀ SFERICA - MISURE
METRICHE E IN POLLICI**

| FEFMEC articolo | ESAGONO mm & pollici | |
|--------------------|--|---|
| 3600 | 0,7 - 0,9 - 1,3 - 1,5 - 2 2,5 - 3 - 4 - 4,5 - 5 - 5,5 6 - 7 - 8 - 10 mm 0,028" - 0,035" - 0,050" 1/16" - 5/64" - 3/32" 7/64" - 1/8" - 9/64" 5/32" - 3/16" - 7/32" 1/4" - 5/46" - 3/8" | 1 |



| BGS articolo | DESCRIZIONE |
|-----------------|---|
| BGS 810 | SERIE 30 PEZZI, CHIAVI MASCHIO ESAGONALI PIEGATE, MISURE IN POLLICI E METRICHE |

CARATTERISTICHE

- finitura nera
- misure metriche: 0,7 - 0,9 - 1,3 - 1,5 - 2 - 2,5 - 3 - 4 - 4,5 - 5 - 5,5 - 6 - 7 - 8 - 10 mm
- misure in pollici: 0,028" - 0,035" - 0,050" - 1/16" - 5/64" - 3/32" - 7/64" - 1/8" - 9/64" - 5/32" - 3/16" - 7/32" - 1/4" - 5/16" - 3/8"
- in custodia ripiegabile
- peso 850 g



| BGS articolo | DESCRIZIONE |
|-----------------|---|
| BGS 7842 | SERIE 8 PEZZI, CHIAVI MASCHIO ESAGONALI PIEGATE 2-10 MM, SU ANELLO |

CARATTERISTICHE

- misure:
 - 2,0 mm (lung. 50 x 17 mm) - 2,5 mm (lung. 54 x 18 mm)
 - 3,0 mm (lung. 57 x 21 mm) - 4,0 mm (lung. 67 x 26 mm)
 - 5,0 mm (lung. 75 x 29 mm) - 6,0 mm (lung. 87 x 33 mm)
 - 8,0 mm (lung. 103 x 40 mm) - 10 mm (lung. 119 x 43 mm)
- finitura nichelata
- peso 220 g

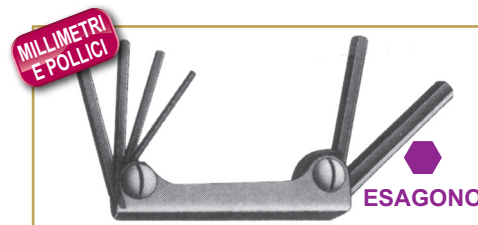

**SERIE 7 CHIAVI ESAGONALI TCCE
STRUTTURA IN ACCIAIO - BRUNITE MISURE
METRICHE E IN POLLICI**

| FEFMEC articolo | ESAGONO | |
|--------------------|--|---|
| 700-H-2510 | 2,5-3-4-5-6 8-10 mm | 1 |
| 700-H-132 | 1/16" - 5/64" - 3/32" 1/8" - 5/32" 3/16" - 7/32" | 1 |
| 700-H-338 | 3/32" - 1/8" - 5/32" 3/16" - 1/4" 5/16" - 3/8" | 1 |



| BGS articolo | DESCRIZIONE |
|-----------------|--|
| BGS 787 | SERIE 7 PEZZI, CHIAVI DA TASCA MASCHIO ESAGONALI, 2,5-10 MM |

CARATTERISTICHE

- materiale: Acciaio Chrome Vanadium
- misure: 2,5 - 3 - 4 - 5 - 6 - 8 - 10 mm
- peso 300 g

LUNGHE

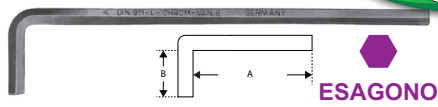

ESAGONO

TIPO LUNGO PIEGATE BRUNITE

| FEIMEC articolo | mm | A x B mm |  |
|--------------------|-----|-------------|---|
| 911-L-1,5 | 1,5 | 90 X 14 | 1 |
| 911-L-2 | 2 | 100 X 15 | 1 |
| 911-L-2,5 | 2,5 | 112 X 18 | 1 |
| 911-L-3 | 3 | 126 X 20 | 1 |
| 911-L-3,5 | 3,5 | 136 X 22 | 1 |
| 911-L-4 | 4 | 142 X 25 | 1 |
| 911-L-4,5 | 4,5 | 150 X 27 | 1 |
| 911-L-5 | 5 | 160 X 28 | 1 |
| 911-L-5,5 | 5,5 | 160 X 28 | 1 |
| 911-L-6 | 6 | 180 X 32 | 1 |
| 911-L-7 | 7 | 180 X 32 | 1 |
| 911-L-8 | 8 | 190 X 34 | 1 |
| 911-L-9 | 9 | 200 X 36 | 1 |
| 911-L-10 | 10 | 210 X 38 | 1 |
| 911-L-11 | 11 | 224 X 40 | 1 |
| 911-L-12 | 12 | 236 X 42 | 1 |
| 911-L-13 | 13 | 250 X 45 | 1 |
| 911-L-14 | 14 | 264 X 50 | 1 |
| 911-L-15 | 15 | 280 X 55 | 1 |
| 911-L-16 | 16 | 285 X 56 | 1 |
| 911-L-17 | 17 | 290 X 58 | 1 |
| 911-L-19 | 19 | 360 X 70 | 1 |
| 911-L-22 | 22 | 400 X 80 | 1 |
| 911-L-24 | 24 | 448 X 90 | 1 |

SATINATE

XXL

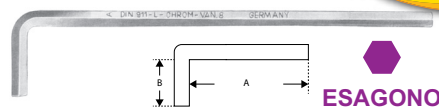

ESAGONO

TIPO LUNGO PIEGATE SATINATE

| FEIMEC articolo | mm | A x B mm |  |
|--------------------|-----|-------------|---|
| 911-L-1,5 C | 1,5 | 90 X 14 | 1 |
| 911-L-2 C | 2 | 100 X 15 | 1 |
| 911-L-2,5 C | 2,5 | 112 X 18 | 1 |
| 911-L-3 C | 3 | 126 X 20 | 1 |
| 911-L-3,5 C | 3,5 | 136 X 22 | 1 |
| 911-L-4 C | 4 | 142 X 25 | 1 |
| 911-L-4,5 C | 4,5 | 150 X 27 | 1 |
| 911-L-5 C | 5 | 160 X 28 | 1 |
| 911-L-5,5 C | 5,5 | 160 X 28 | 1 |
| 911-L-6 C | 6 | 180 X 32 | 1 |
| 911-L-7 C | 7 | 180 X 32 | 1 |
| 911-L-8 C | 8 | 190 X 34 | 1 |
| 911-L-9 C | 9 | 200 X 36 | 1 |
| 911-L-10 C | 10 | 210 X 38 | 1 |
| 911-L-11 C | 11 | 224 X 40 | 1 |
| 911-L-12 C | 12 | 236 X 42 | 1 |
| 911-L-13 C | 13 | 250 X 45 | 1 |
| 911-L-14 C | 14 | 264 X 50 | 1 |
| 911-L-15 C | 15 | 280 X 55 | 1 |
| 911-L-16 C | 16 | 285 X 56 | 1 |
| 911-L-17 C | 17 | 290 X 58 | 1 |
| 911-L-19 C | 19 | 360 X 70 | 1 |
| 911-L-22 C | 22 | 400 X 80 | 1 |
| 911-L-24 C | 24 | 448 X 90 | 1 |



| ESAGONO BGS articolo | DESCRIZIONE |
|----------------------------|--|
| BGS 808 | SERIE 9 PEZZI, CHIAVI MASCHIO ESAGONALI PIEGATE EXTRA-LUNGHE, ESTREMITÀ DRITTE, 1,5-10 MM |

CARATTERISTICHE

- entrambe le estremità dritte
- misure: 1,5-2-2,5-3-4-5-6-8-10 mm
- peso 470 g



ESAGONO

ESAGONO

SERIE 10 CHIAVI ESAGONALI TCCE BRUNITE TIPO LUNGO

| FEIMEC articolo | mm |  |
|--------------------|------------------------------|---|
| 911-111-CLIP | 1,5-2-2,5-3-4-5 6-8-10 | 1 |
| 911-112-CLIP | 1,5-2-2,5-3-4-5 6-8-10-12 | 1 |



ESAGONO

ESAGONO

SERIE 9 CHIAVI ESAGONALI TCCE SATINATE TIPO LUNGO

| FEIMEC articolo | mm |  |
|--------------------|---|---|
| 911-110 LC | 1,5 - 2 - 2,5 - 3 - 4 5 - 6 - 8 - 10 | 1 |

POLLICI

ESAGONO

TIPO LUNGO PIEGATE BRUNITE IN POLLICI

| #FERMEC articolo | pollici | A x B mm | |
|------------------|---------|----------|---|
| 911-L-1/16" | 1/16" | 90 X 14 | 1 |
| 911-L-5/64" | 5/64" | 100 X 15 | 1 |
| 911-L-3/32" | 3/32" | 112 X 18 | 1 |
| 911-L-1/8" | 1/8" | 126 X 20 | 1 |
| 911-L-9/64" | 9/64" | 136 X 22 | 1 |
| 911-L-5/32" | 5/32" | 142 X 25 | 1 |
| 911-L-3/16" | 3/16" | 160 X 28 | 1 |
| 911-L-7/32" | 7/32" | 160 X 32 | 1 |
| 911-L-1/4" | 1/4" | 180 X 32 | 1 |
| 911-L-9/32" | 9/32" | 190 X 34 | 1 |
| 911-L-5/16" | 5/16" | 200 X 36 | 1 |
| 911-L-11/32" | 11/32" | 210 X 38 | 1 |
| 911-L-3/8" | 3/8" | 224 X 40 | 1 |
| 911-L-7/16" | 7/16" | 236 X 42 | 1 |
| 911-L-1/2" | 1/2" | 264 X 50 | 1 |
| 911-L-9/16" | 9/16" | 280 X 55 | 1 |
| 911-L-5/8" | 5/8" | 290 X 58 | 1 |
| 911-L-3/4" | 3/4" | 360 X 70 | 1 |
| 911-L-7/8" | 7/8" | 400 X 80 | 1 |

ESAGONO

5x150mm

ESAGONO

CHIAVI MASCHIO ESAGONALE A DUE TESTE SATINATE CON IMPUGNATURA IN PLASTICA

| #FERMEC articolo | mm | L mm | |
|------------------|-----|------|---|
| 5305-2 | 2 | 100 | 1 |
| 5305-2,5 | 2,5 | 100 | 1 |
| 5305-3 | 3 | 100 | 1 |
| 5305-4 | 4 | 150 | 1 |
| 5305-5 | 5 | 150 | 1 |
| 5305-6 | 6 | 150 | 1 |
| 5305-7 | 7 | 150 | 1 |
| 5305-8 | 8 | 200 | 1 |
| 5305-10 | 10 | 200 | 1 |

ESAGONO

BGS

ESAGONO

PRO+ CV

CHIAVI ESAGONALI CON IMPUGNATURA A "T"

| BGS articolo | mm | L mm |
|--------------|-----|------|
| BGS 4010-1 | 2 | 90 |
| BGS 4010-2 | 2,5 | 100 |
| BGS 4010-3 | 3 | 115 |
| BGS 4010-4 | 4 | 120 |
| BGS 4010-5 | 5 | 140 |
| BGS 4010-6 | 6 | 160 |
| BGS 4010-7 | 7 | 170 |
| BGS 4010-8 | 8 | 175 |
| BGS 4010-9 | 10 | 200 |

POLLICI

ESAGONO

ESAGONO

SERIE 10 CHIAVI ESAGONALI TCCE BRUNITE TIPO LUNGO

| #FERMEC articolo | pollici | |
|------------------|--|---|
| 911-162-CLIP | 1/16"-5/64"-3/32" 1/8"-5/32"-3/16" 1/4"-5/16" 3/8"-1/2" | 1 |

ESAGONO

PRO+ CV

| BGS articolo | DESCRIZIONE |
|--------------|---|
| BGS 8484 | SET 8 PEZZI, CHIAVI ESAGONALI PIEGATE CON IMPUGNATURA, 2 - 10 MM |

CARATTERISTICHE

- misure: 2 x 90 mm; 2,5 x 100 mm, 3 x 115 mm, 4 x 120 mm, 5 x 140 mm, 6 x 160 mm, 8 x 175 mm, 10 x 200 mm
- chiavi con doppio esagono maschio
- impugnatura ergonomica
- su supporto in metallo
- peso 1,2 kg

RICAMBI

| BGS articolo | DESCRIZIONE |
|--------------|-----------------------|
| BGS 8484-1 | SUPPORTO VUOTO |

CHIAVI MASCHIO

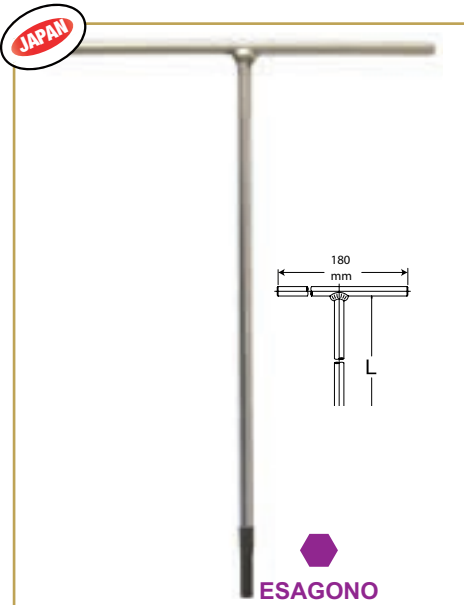

CHIAVI ESAGONALI TCCE A "T" TIPO LUNGO CROMATE

| Koken articolo | mm | L mm | |
|----------------|----|------|---|
| 157 HE-3 | 3 | 250 | 1 |
| 157 HE-4 | 4 | 250 | 1 |
| 157 HE-5 | 5 | 250 | 1 |
| 157 HE-6 | 6 | 250 | 1 |
| 157 HE-8 | 8 | 250 | 1 |
| 157 HE-10 | 10 | 300 | 1 |
| 157 HE-12 | 12 | 320 | 1 |



CHIAVI ESAGONALI TCCE A "T" EXTRA LUNGO JUMBO BRUNITE

| FEIMEC articolo | mm | L mm | |
|-----------------|----|------|---|
| 4503 | 3 | 450 | 1 |
| 4504 | 4 | 450 | 1 |
| 4505 | 5 | 450 | 1 |
| 4506 | 6 | 450 | 1 |
| 4508 | 8 | 450 | 1 |

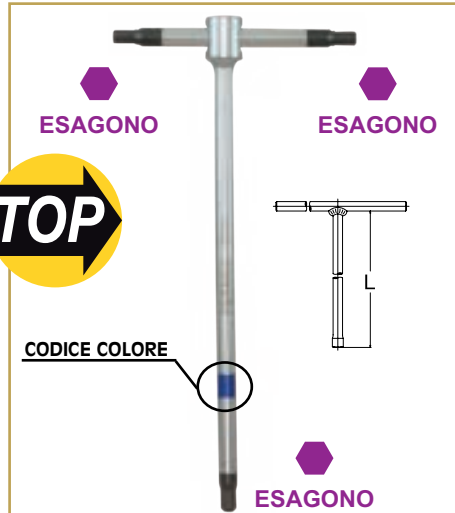

CHIAVI A "T" 3 TESTE MASCHIO ESAGONALI CON ASTA SCORREVOLE CHROM-VANADIUM

OGNI MISURA UN COLORE

| FEIMEC articolo | mm | L mm | |
|-----------------|-----|------|---|
| 695-2 | 2 | 125 | 1 |
| 695-2,5 | 2,5 | 125 | 1 |
| 695-3 | 3 | 125 | 1 |
| 695-3,5 | 3,5 | 125 | 1 |
| 695-4 | 4 | 180 | 1 |
| 695-4,5 | 4,5 | 180 | 1 |
| 695-5 | 5 | 180 | 1 |
| 695-6 | 6 | 210 | 1 |
| 695-7 | 7 | 210 | 1 |
| 695-8 | 8 | 250 | 1 |
| 695-10 | 10 | 300 | 1 |
| 695-12 | 12 | 320 | 1 |
| 695-14 | 14 | 340 | 1 |



ESAGONO

ASSORTIMENTO 8 PEZZI CHIAVI A "T" 3 TESTE MASCHIO ESAGONALI CHROM-VANADIUM ASTA SCORREVOLE

| FEIMEC articolo | mm | |
|-----------------|--------------------------|---|
| 695-2060 | 2-2,5-3-3,5-4 4,5-5-6 | 1 |



CHIAVI A "T" 3 TESTE MASCHIO ESAGONALI CON ASTA SCORREVOLE CHROM-VANADIUM

| FEIMEC articolo | pollici | L mm | |
|-----------------|---------|------|---|
| 796-3/32 | 3/32" | 125 | 1 |
| 796-1/8 | 1/8" | 125 | 1 |
| 796-5/32 | 5/32" | 180 | 1 |
| 796-3/16 | 3/16" | 180 | 1 |
| 796-7/32 | 7/32" | 180 | 1 |
| 796-1/4 | 1/4" | 210 | 1 |
| 796-5/16 | 5/16" | 250 | 1 |



CHIAVI A "T" 3 TESTE MASCHIO ESAGONALI CON ASTA SCORREVOLE E TESTA SFERICA IN UN SOLO LATO

| FEIMEC articolo | mm | L mm | |
|-----------------|----|------|---|
| 651-3 | 3 | 125 | 1 |
| 651-4 | 4 | 180 | 1 |
| 651-5 | 5 | 180 | 1 |
| 651-6 | 6 | 210 | 1 |



ESAGONO

CHIAVI A "T" SNODATE ESAGONALI
LUNGHEZZA 500 MM

| FEEMEC articolo | mm | L mm | |
|--------------------|----|---------|---|
| 585-3 | 3 | 500 | 1 |
| 585-4 | 4 | 500 | 1 |
| 585-5 | 5 | 500 | 1 |
| 585-6 | 6 | 500 | 1 |
| 585-8 | 8 | 500 | 1 |



ESAGONO

PRO+



BGS
articolo

DESCRIZIONE

SERIE 5 PEZZI,
CHIAVI CON
IMPUGNATURA A T
MASCHIO ESAGONALI,
3X100 - 8X200 MM

BGS 773

CARATTERISTICHE

- finitura satinata cromata
- impugnature a T dalla forma ergonomica
- misure:
3x100 mm - 4x100 mm - 5x150 mm - 6x150 mm
8x200 mm
- peso 650 g



ESAGONO
IMPUGNATURA A "T" CON LAMA
ESAGONALE

| FEEMEC articolo | mm | L mm | |
|--------------------|-----|---------|---|
| 500-2-100 | 2 | 100 | 1 |
| 500-2,5-100 | 2,5 | 100 | 1 |
| 500-3-100 | 3 | 100 | 1 |
| 500-3-150 | 3 | 150 | 1 |
| 500-3-200 | 3 | 200 | 1 |
| 500-3-300 | 3 | 300 | 1 |

| | | | |
|-----------|---|-----|---|
| 500-4-100 | 4 | 100 | 1 |
| 500-4-150 | 4 | 150 | 1 |
| 500-4-200 | 4 | 200 | 1 |
| 500-4-300 | 4 | 300 | 1 |

| | | | |
|-----------|---|-----|---|
| 500-5-100 | 5 | 100 | 1 |
| 500-5-150 | 5 | 150 | 1 |
| 500-5-200 | 5 | 200 | 1 |
| 500-5-350 | 5 | 350 | 1 |

| | | | |
|-----------|---|-----|---|
| 500-6-100 | 6 | 100 | 1 |
| 500-6-150 | 6 | 150 | 1 |
| 500-6-200 | 6 | 200 | 1 |
| 500-6-350 | 6 | 350 | 1 |

| | | | |
|-----------|---|-----|---|
| 500-8-100 | 8 | 100 | 1 |
| 500-8-150 | 8 | 150 | 1 |
| 500-8-200 | 8 | 200 | 1 |
| 500-8-350 | 8 | 350 | 1 |

| | | | |
|------------|----|-----|---|
| 500-10-200 | 10 | 200 | 1 |
| 500-12-200 | 12 | 200 | 1 |



ESAGONO

IMPUGNATURA A "T" CON LAMA
ESAGONALE TESTA SFERICA

| FEEMEC articolo | mm | L mm | |
|--------------------|----|---------|---|
| 550-4-350 | 4 | 350 | 1 |
| 550-5-350 | 5 | 350 | 1 |
| 550-6-350 | 6 | 350 | 1 |



ESAGONO



BGS
articolo

DESCRIZIONE

BGS 791

SERIE 10 PEZZI,
CHIAVI CON
IMPUGNATURA A T
MASCHIO ESAGONALI,
2-10 MM

CARATTERISTICHE

- Impugnatura a T
- misure (lunghezza lama):
2 (83 mm) - 2,5 (87 mm) - 3 (94 mm) - 4 (97 mm)
4,5 (105 mm) - 5 (110 mm) - 5,5 (105 mm)
6 (110 mm) - 8 (118 mm) - 10 (125 mm)
- su supporto
- peso 1,0 kg

POLLICI



ESAGONO

IMPUGNATURA A "T" CON LAMA ESAGONALE MISURE IN POLLICI

| FEIMEC articolo | ESAGONO pollici | L mm | |
|-----------------|-----------------|------|---|
| 500-5/64" | 5/64" | 100 | 1 |
| 500-3/32" | 3/32" | 100 | 1 |
| 500-1/8" | 1/8" | 150 | 1 |
| 500-5/32" | 5/32" | 150 | 1 |
| 500-3/16" | 3/16" | 150 | 1 |
| 500-1/4" | 1/4" | 150 | 1 |
| 500-5/16" | 5/16" | 200 | 1 |
| 500-3/8" | 3/8" | 200 | 1 |



ESAGONO



SERIE 6 CHIAVI ESAGONALI ISOLATE VDE

| FEIMEC articolo | ESAGONO mm | |
|-----------------|---------------|---|
| 35600 | 2,5-3-4-5-6-8 | 1 |

SPECIALE PROFILO PER ESAGONI ROVINATI

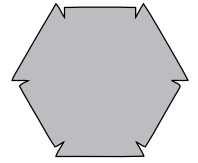

ESAGONO

| BGS articolo | DESCRIZIONE |
|--------------|---|
| BGS 8512 | SERIE 9 PEZZI, CHIAVI A L ESAGONALI CON PROFILO SPECIALE, 1,5-10 MM |

CARATTERISTICHE

- profilo speciale per estrarre viti a brugola con esagono incassato rovinato
- misure: 1,5 - 2 - 2,5 - 3 - 4 - 5 - 6 - 8 - 10 mm
- con custodia pieghevole
- peso 480 g

POLLICI



ESAGONO



| BGS articolo | DESCRIZIONE |
|--------------|---|
| BGS 7099 | SET 10 PEZZI, CHIAVI CON IMPUGNATURA A T MASCHIO ESAGONALI IN POLLICI, 3/32"-3/8" |

CARATTERISTICHE

- Impugnatura a T
- misure: 3/32" - 7/64" - 1/8" - 9/64" - 5/32" - 3/16" - 7/32" - 1/4" - 5/16" - 3/8"
- su supporto
- peso 1,0 kg

JAPAN



ESAGONO

SERIE 9 CHIAVI CROMATE ESAGONALI CON 2 LATI EXTRA CORTI PER ENTRARE ANCHE IN SPAZI RISTRETTI

2 LATI EXTRA CORTI DISASSATI

| FEIMEC articolo | ESAGONO mm | |
|-----------------|------------------------|---|
| 33450 | 1,5-2-2,5-3-4-5-6-8-10 | 1 |

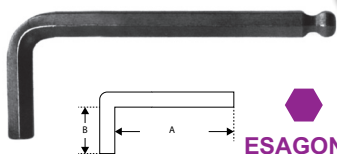

ESAGONO

CHIAVI A BRUGOLA TCCE CON ESTREMITÀ SFERICA BRUNITE

| FEFMEC articolo | mm | A x B mm | |
|-----------------|-----|----------|---|
| 300-1,5 | 1,5 | 80 X 13 | 1 |
| 300-2 | 2 | 85 X 16 | 1 |
| 300-2,5 | 2,5 | 90 X 17 | 1 |
| 300-3 | 3 | 100 X 19 | 1 |
| 300-4 | 4 | 110 X 25 | 1 |
| 300-5 | 5 | 128 X 27 | 1 |
| 300-6 | 6 | 150 X 30 | 1 |
| 300-8 | 8 | 170 X 35 | 1 |
| 300-10 | 10 | 190 X 40 | 1 |
| 300-12 | 12 | 220 X 45 | 1 |
| 300-14 | 14 | 280 X 55 | 1 |
| 300-17 | 17 | 320 X 60 | 1 |
| 300-19 | 19 | 360 X 70 | 1 |

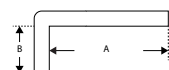

ESAGONO

SERIE 8 CHIAVI SATINATE CHROM VANADIUM A BRUGOLA TCCE TESTA SFERICA - ESPOSITORE 12 PEZZI A RICHIESTA

| FEFMEC articolo | mm | |
|-----------------|--------------------|---|
| 303-8 | 2-2,5-3-4-5-6-8-10 | 1 |

RICAMBI

| FEFMEC articolo | mm | A x B mm | |
|-----------------|-----|----------|---|
| 303-20 | 2 | 85 X 16 | 1 |
| 303-25 | 2,5 | 90 X 17 | 1 |
| 303-30 | 3 | 100 X 19 | 1 |
| 303-40 | 4 | 110 X 25 | 1 |
| 303-50 | 5 | 128 X 27 | 1 |
| 303-60 | 6 | 150 X 30 | 1 |
| 303-80 | 8 | 170 X 35 | 1 |
| 303-100 | 10 | 190 X 40 | 1 |



ESAGONO

SERIE 9 CHIAVI ESAGONALI TCCE CON ESTREMITÀ SFERICA - BRUNITE

| FEFMEC articolo | mm | |
|-----------------|------------------------|---|
| 300-9-CLIP | 1,5-2-2,5-3-4-5-6-8-10 | 1 |



ESAGONO

SERIE 9 CHIAVI ESAGONALI CORTE CON ESTREMITÀ SFERICA - SATINATE

| FEFMEC articolo | mm | |
|-----------------|------------------------|---|
| 902-CLIP | 1,5-2-2,5-3-4-5-6-8-10 | 1 |



ESAGONO



| BGS articolo | DESCRIZIONE |
|--------------|---|
| BGS 815 | SERIE 9 PEZZI, CHIAVI MASCHIO ESAGONALI PIEGATE 1,5-10 MM, CON ESTREMITÀ SFERICA |

CARATTERISTICHE

- misure: 1,5 - 2 - 2,5 - 3 - 4 - 5 - 6 - 8 - 10 mm
- lato lungo con testa a sfera: permette l'inclinazione della chiave fino a 30°
- tipo lungo, lunghezza fino a 185 mm
- su supporto in plastica
- peso 350 g

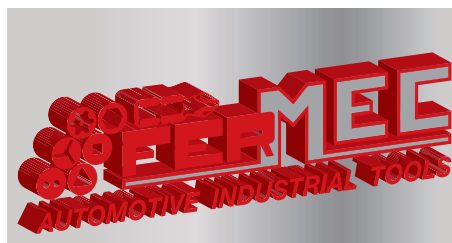



LATO EXTRA CORTO



ESAGONO



SERIE 9 CHIAVI CROMATE ESAGONALI TIPO LUNGO CON ESTREMITÀ SFERICA + LATO EXTRA CORTO

FEARMEC

| articolo | mm | |
|----------|------------------------|---|
| 31950 | 1,5-2-2,5-3-4-5-6-8-10 | 1 |

SATINATE

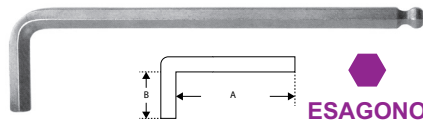

ESAGONO

CHIAVI A BRUGOLA TCCE CON ESTREMITÀ SFERICA TIPO LUNGO - SATINATE

| FEARMEC articolo | mm | A x B mm | |
|------------------|-----|----------|---|
| 302-1,5 | 1,5 | 90 X 14 | 1 |
| 302-2 | 2 | 110 X 16 | 1 |
| 302-2,5 | 2,5 | 120 X 18 | 1 |
| 302-3 | 3 | 126 X 20 | 1 |
| 302-4 | 4 | 142 X 25 | 1 |
| 302-5 | 5 | 160 X 28 | 1 |
| 302-6 | 6 | 180 X 32 | 1 |
| 302-7 | 7 | 180 X 32 | 1 |
| 302-8 | 8 | 200 X 36 | 1 |
| 302-10 | 10 | 224 X 40 | 1 |
| 302-12 | 12 | 250 X 45 | 1 |
| 302-14 | 14 | 280 X 56 | 1 |
| 302-17 | 17 | 320 X 63 | 1 |



SET 13 CHIAVI



ESAGONO

PRO+



BGS articolo

DESCRIZIONE

BGS 9799

SERIE 13 PEZZI, CHIAVI MASCHIO ESAGONALI PIEGATE, TESTA SFERICA, 1,27-10 MM

CARATTERISTICHE

- estremità lunghe con testa sferica
- in supporto pieghevole
- misure:
 - esagono 1.27 mm, lunghezza 89 mm
 - esagono 1.5 mm, lunghezza 100 mm
 - esagono 2 mm, lunghezza 112 mm
 - esagono 2.5 mm, lunghezza 126 mm
 - esagono 3 mm, lunghezza 140 mm
 - esagono 3.5 mm, lunghezza 155 mm
 - esagono 4 mm, lunghezza 160 mm
 - esagono 4.5 mm, lunghezza 174 mm
 - esagono 5 mm, lunghezza 182 mm
 - esagono 5.5 mm, lunghezza 193 mm
 - esagono 6 mm, lunghezza 200 mm
 - esagono 8 mm, lunghezza 215 mm
 - esagono 10 mm, lunghezza 230 mm
- peso 740 g

XXL

LATO EXTRA CORTO



ESAGONO

PRO+



BGS articolo

DESCRIZIONE

BGS 9374

SERIE 9 PEZZI, CHIAVI MASCHIO ESAGONALI PIEGATE EXTRA-LUNGHE, LATO CORTO EXTRA -CORTO, TESTA SFERICA, 1,5-10 MM

CARATTERISTICHE

- dimensioni (misura x lunghezza):
 - 1,5 mm: 11 x 80 mm
 - 2,0 mm: 13 x 100 mm
 - 2,5 mm: 14 x 110 mm
 - 3,0 mm: 15 x 130 mm
 - 4,0 mm: 19 x 150 mm
 - 5,0 mm: 21 x 150 mm
 - 6,0 mm: 25 x 185 mm
 - 8,0 mm: 36 x 210 mm
 - 10,0 mm: 36 x 230 mm
- estremità lunga con testa sferica
- lato corto extra-corto
- finitura satinata cromata
- con custodia pieghevole in plastica blu/nera
- peso 470 g

SATINATE



ESAGONO



SERIE 9 CHIAVI ESAGONALI TCCE CON ESTREMITÀ SFERICA TIPO LUNGO SATINATE

FEARMEC articolo

302-9-CLIP

mm

1,5-2-2,5-3-4-5
6-8-10



1

POLLICI



**SET
13
CHIAVI**



ESAGONO

PRO+



**CV
S2**

BGS
articolo

DESCRIZIONE

BGS 9801

**SERIE 13 PEZZI,
CHIAVI MASCHIO
ESAGONALI PIEGATE,
TESTA SFERICA, IN
POLLICI, 0.05"-3/8"**

CARATTERISTICHE

- estremità lunghe con testa sferica
- in supporto pieghevole
- misure:
 - esagono 0.5", lunghezza 80 mm
 - esagono 1/16", lunghezza 90 mm
 - esagono 5/64", lunghezza 100 mm
 - esagono 3/32", lunghezza 112 mm
 - esagono 7/64", lunghezza 115 mm
 - esagono 1/8", lunghezza 126 mm
 - esagono 9/64", lunghezza 132 mm
 - esagono 5/32", lunghezza 140 mm
 - esagono 3/16", lunghezza 163 mm
 - esagono 7/32", lunghezza 167 mm
 - esagono 1/4", lunghezza 182 mm
 - esagono 5/16", lunghezza 205 mm
 - esagono 3/8", lunghezza 230 mm
- peso 520 g

NEW

**POLLICI
SATINATE**



**TORX
CON FORO**



**TORX
CON FORO**

CV



**ESAGONO TORX
CON FORO**

BGS
articolo

DESCRIZIONE

BGS 822

**SERIE 18 PEZZI,
CHIAVI A L,
ESAGONALI E
TORX CON FORO**

CARATTERISTICHE

- su due supporti pieghevoli
- chiavi a L Esagonali, con testa sferica sul lato lungo:
 - 1,5 mm (15 x 90 mm); 2 mm (17 x 100 mm)
 - 2,5 mm (20 x 110 mm); 3 mm (22 x 127 mm)
 - 4 mm (28 x 140 mm); 5 mm (32 x 160 mm)
 - 6 mm (36 x 183 mm); 8 mm (40 x 203 mm)
 - 10 mm (48 x 230 mm)
- chiavi a L Torx con Foro (su entrambe le estremità):
 - TH10 (18 x 52 mm); TH15 (19 x 58 mm);
 - TH20 (22 x 62 mm); TH25 (26 x 68 mm);
 - TH27 (30 x 76 mm); TH30 (32 x 82 mm);
 - TH40 (36 x 92 mm); TH45 (42 x 106 mm);
 - TH50 (46 x 118 mm)
- peso 700 g

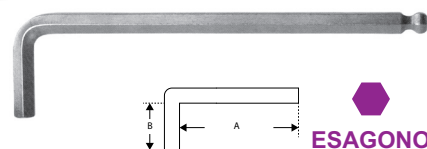

ESAGONO

**CHIAVI A BRUGOLA TCCE CON ESTREMITÀ
SFERICA TIPO LUNGO - SATINATE**

| FEARMEC articolo | ESAGONO pollici | A x B mm | ESAGONO mm |
|---------------------|--------------------|-------------|---------------|
| 302-1/16" | 1/16" | 90 X 14 | 1 |
| 302-5/64" | 5/64" | 110 X 16 | 1 |
| 302-3/32" | 3/32" | 120 X 18 | 1 |
| 302-1/8" | 1/8" | 126 X 20 | 1 |
| 302-5/32" | 5/32" | 142 X 25 | 1 |
| 302-3/16" | 3/16" | 160 X 28 | 1 |
| 302-1/4" | 1/4" | 180 X 32 | 1 |
| 302-5/16" | 5/16" | 200 X 36 | 1 |
| 302-3/8" | 3/8" | 224 X 40 | 1 |

POLLICI

NEW



ESAGONO

PRO+



**CV
S2**

BGS
articolo

DESCRIZIONE

BGS 799

**SERIE 9 PEZZI,
CHIAVI MASCHIO
ESAGONALI PIEGATE,
TESTA SFERICA, IN
POLLICI,
1/16"-3/8"**

CARATTERISTICHE

- estremità lunghe con testa sferica
- in supporto pieghevole
- misure:
 - esagono 1/16", 17 x 95 mm
 - esagono 5/64", 19 x 105 mm
 - esagono 3/32", 22 x 115 mm
 - esagono 1/8", 25 x 130 mm
 - esagono 5/32", 30 x 145 mm
 - esagono 3/16", 35 x 165 mm
 - esagono 1/4", 40 x 190 mm
 - esagono 5/16", 45 x 210 mm
 - esagono 3/8", 50 x 240 mm
- peso 460 g



TOP



art. 32519

art. 96950

ESAGONO



TORX®

TORX®
CON FORO



FERMEC
articolo
325950

DESCRIZIONE

**ESPOSITORE 10 SERIE, CHIAVI ESAGONALI E TORX COLORATE
MAGNETICHE**

CARATTERISTICHE

- espositore composto da:
 - 5 serie di chiavi esagonali magnetiche art. 32519
 - 5 serie di chiavi Torx magnetiche art. 96950



ESAGONO



OGNI MISURA
UN COLORE

**SERIE 9 CHIAVI ESAGONALI TESTA SFERICA
TIPO EXTRA LUNGO, CON MAGNETE
ALLOGGIATO NELLA PARTE SFERICA PER
TRATTENERE LA VITE RIVESTIMENTO
ANTISCIVOLO**

| FERMEC articolo | ESAGONO mm | |
|---------------------------|---------------------------|---|
| 32519 | 1,5-2-2,5-3-4-5 6-8-10 | 1 |
| RICAMBI | | |
| FERMEC articolo | ESAGONO mm | |
| 32519-1,5 | 1,5 | 1 |
| 32519-2 | 2 | 1 |
| 32519-2,5 | 2,5 | 1 |
| 32519-3 | 3 | 1 |
| 32519-4 | 4 | 1 |
| 32519-5 | 5 | 1 |
| 32519-6 | 6 | 1 |
| 32519-8 | 8 | 1 |
| 32519-10 | 10 | 1 |



POLLICI

ESAGONO

TESTA SFERICA PRO+ CV

| | |
|---|---|
| BGS tecnologic articolo | DESCRIZIONE |
| BGS 35100 | SERIE 9 PEZZI, CHIAVI A L ESAGONALI CON TESTA SFERICA MAGNETICA, 1,5-10 MM |
| CARATTERISTICHE | |
| <ul style="list-style-type: none"> • magnete alloggiato nella parte sferica per trattenere la vite • misure: 1,5 - 2 - 2,5 - 3 - 4 - 5 - 6 - 8 - 10 mm • rivestimento antiscivolo • con custodia pieghevole • peso 460 g | |



POLLICI

ESAGONO

TESTA SFERICA PRO+ CV

| | |
|---|--|
| BGS tecnologic articolo | DESCRIZIONE |
| BGS 35101 | SERIE 9 PEZZI, CHIAVI ESAGONALI IN POLLICI, CON TESTA SFERICA MAGNETICA |
| CARATTERISTICHE | |
| <ul style="list-style-type: none"> • misure: 1/16" - 5/64" - 3/32" - 1/8" - 5/32" - 3/16" - 1/4" - 5/16" - 3/8" • tipo lungo • testa sferica con magnete • rivestimento antiscivolo • peso 450 g | |



INOX

ESAGONO

TESTA SFERICA

SERIE 9 CHIAVI ESAGONALI ESAGONALI TESTA SFERICA IN ACCIAIO INOX TIPO LUNGO

| | | |
|--------------------|---------------------------|---|
| FEEMEC articolo | mm | |
| 32850 | 1,5-2-2,5-3-4-5 6-8-10 | 1 |





ESAGONO

SERIE 7 CHIAVI ESAGONALI TCCE CON ESTREMITÀ SFERICA STRUTTURA IN ACCIAIO BRUNITE

| FEARMEC articolo | mm | |
|------------------|------------------|---|
| 310-H-2510 | 2,5-3-4-5-6-8-10 | 1 |

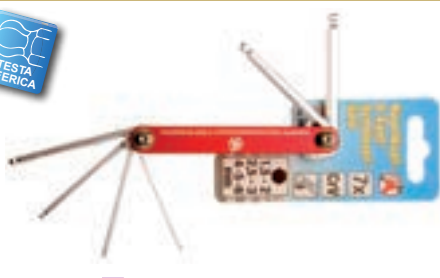

ESAGONO



| BGS articolo | DESCRIZIONE |
|--------------|---|
| BGS 7847 | SERIE CHIAVI MASCHIO ESAGONALI CON TESTA SFERICA, 1,5 - 6 MM |

CARATTERISTICHE

- misure: 1,5 - 2 - 2,5 - 3 - 4 - 5 - 6 mm
- con testa sferica
- impugnatura in alluminio anodizzato rosso
- chiavi cromate satinare
- dimensioni: 99 x 32 x 19 mm
- peso 110 g



ESAGONO

CHIAVI ESAGONALI PIEGATE CON UNA ESTREMITÀ SFERICA ED IMPUGNATURA ERGONOMICA

| FEARMEC articolo | mm | L mm | |
|------------------|-----|----------|---|
| 305-2,5 | 2,5 | 90 X 12 | 1 |
| 305-3 | 3 | 90 X 12 | 1 |
| 305-4 | 4 | 130 X 12 | 1 |
| 305-5 | 5 | 130 X 15 | 1 |
| 305-6 | 6 | 175 X 15 | 1 |
| 305-8 | 8 | 175 X 15 | 1 |
| 305-10 | 10 | 175 X 15 | 1 |



ESAGONO



| BGS articolo | DESCRIZIONE |
|--------------|---|
| BGS 795 | SET 10 PEZZI, CHIAVI MASCHIO ESAGONALI PIEGATE XL, 3X130-17X340 MM |

CARATTERISTICHE

- finitura cromata
- forgiate
- per viti a esagono incassato
- contenuto (misura x lunghezza), 3x130 mm, 4x145 mm, 5x165 mm, 6x185 mm, 7x195 mm, 8x210 mm, 10x230 mm, 12x265 mm, 14x290 mm, 17x335 mm
- in valigetta
- peso 2,5 kg

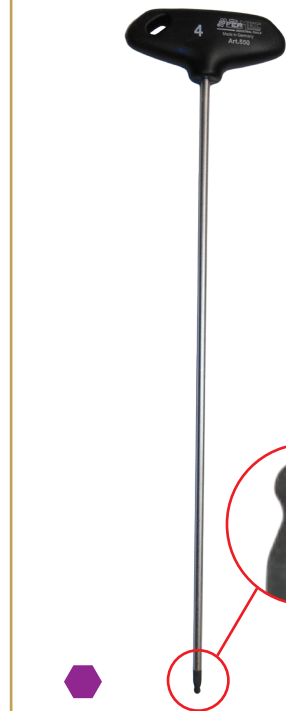

ESAGONO

IMPUGNATURA A "T" CON LAMA ESAGONALE TESTA SFERICA

| FEARMEC articolo | mm | L mm | |
|------------------|----|------|---|
| 550-4-350 | 4 | 350 | 1 |
| 550-5-350 | 5 | 350 | 1 |
| 550-6-350 | 6 | 350 | 1 |



ESAGONO



| BGS articolo | DESCRIZIONE |
|--------------|--|
| BGS 90 | SET 16 PEZZI, CHIAVI MASCHIO ESAGONALI E TORX CON IMPUGNATURA |

CARATTERISTICHE

- 8 chiavi con impugnatura, Esagonali: 2x75 mm, 2,5x75 mm, 3x100 mm, 4x100 mm, 5x150 mm, 6x150 mm, 8x200 mm, 10x200 mm
- **Testa sferica su lato lungo**
- 8 chiavi con impugnatura, TORX: T1X0x75 mm, TX15x75 mm, TX20x100 mm, T2X5x100 mm, TX30x150 mm, TX40x150 mm, TX45x200 mm, TX50x200 mm
- **TORX senza foro su entrambi i lati**
- con impugnatura antiscivolo
- peso 2,0 kg



ESAGONO



CV



| BGS articolo | mm | L mm | |
|--------------|-----|------|---|
| BGS 7882-2 | 2 | 100 | 1 |
| BGS 7882-2,5 | 2,5 | 100 | 1 |
| BGS 7882-3 | 3 | 100 | 1 |
| BGS 7882-4 | 4 | 150 | 1 |
| BGS 7882-5 | 5 | 150 | 1 |
| BGS 7882-6 | 6 | 150 | 1 |
| BGS 7882-7 | 7 | 150 | 1 |
| BGS 7882-8 | 8 | 200 | 1 |
| BGS 7882-10 | 10 | 200 | 1 |

CARATTERISTICHE

- finitura nera
- estremità lunga con testa sferica
- impugnatura in materiale bi-componente

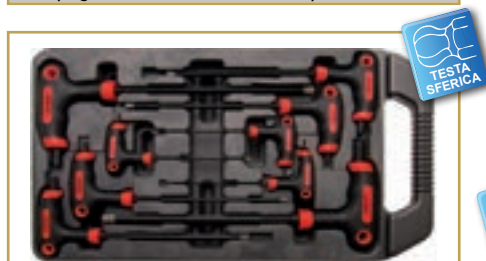

ESAGONO



CV



| BGS articolo | DESCRIZIONE |
|--------------|---|
| BGS 7882 | SET 9 PEZZI, CHIAVI ESAGONALI CON IMPUGNATURA, 2X100 MM 10X200 MM |

CARATTERISTICHE

- lame nere
- estremità lunghe con testa sferica
- comprende: 2x100 mm; 2,5x100 mm; 3x100 mm; 4x150 mm; 5x150 mm; 6x150 mm; 7x150 mm; 8x200 mm; 10x200 mm
- peso 1,7 kg

RICAMBI

| BGS articolo | DESCRIZIONE |
|---------------|--|
| BGS 7880-LEER | CASSETTA VUOTA PER BGS 7880 E BGS 7882 |



ESAGONO



CHIAVI ESAGONALI PIEGATE CON UNA ESTREMITÀ SFERICA ED IMPUGNATURA ANTISCIVOLO "ALTA RESISTENZA"

| BGS articolo | mm | L mm | |
|--------------|-----|------|---|
| 6305-2 | 2 | 100 | 1 |
| 6305-2,5 | 2,5 | 100 | 1 |
| 6305-3 | 3 | 100 | 1 |
| 6305-4 | 4 | 150 | 1 |
| 6305-5 | 5 | 150 | 1 |
| 6305-6 | 6 | 150 | 1 |
| 6305-7 | 7 | 150 | 1 |
| 6305-8 | 8 | 200 | 1 |
| 6305-10 | 10 | 200 | 1 |
| 6305-12 | 12 | 200 | 1 |



ESAGONO

SERIE 10 CHIAVI ESAGONALI PIEGATE IN VALIGETTA PLASTICA TESTA SFERICA

| BGS articolo | mm | |
|--------------|-------------------------|---|
| 6306 | 2-2,5-3-4-5-6-7-8-10-12 | 1 |



ESAGONO



CHIAVI ESAGONALI PIEGATE CON UNA ESTREMITÀ SFERICA ED IMPUGNATURA ANTISCIVOLO "ALTA RESISTENZA" - MISURE IN POLLICI

| BGS articolo | pollici | L mm | |
|--------------|---------|------|---|
| 6307-5/64" | 5/64" | 100 | 1 |
| 6307-3/32" | 3/32" | 100 | 1 |
| 6307-1/8" | 1/8" | 100 | 1 |
| 6307-5/32" | 5/32" | 150 | 1 |
| 6307-3/16" | 3/16" | 150 | 1 |
| 6307-7/32" | 7/32" | 150 | 1 |
| 6307-1/4" | 1/4" | 150 | 1 |
| 6307-5/16" | 5/16" | 200 | 1 |
| 6307-3/8" | 3/8" | 200 | 1 |
| 6307-1/2" | 1/2" | 200 | 1 |



ESAGONO

SERIE 10 CHIAVI ESAGONALI PIEGATE IN VALIGETTA PLASTICA - MISURE IN POLLICI TESTA SFERICA

| BGS articolo | pollici | |
|--------------|---|---|
| 6308 | 5/64"-3/32"-1/8"-5/32" 3/16"-1/4"-7/32" 5/16"-3/8"-1/2" | 1 |

Torx

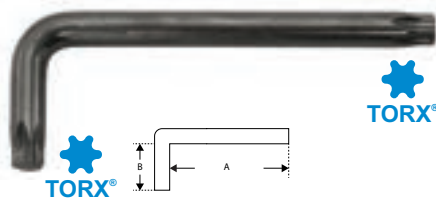

CHIAVI TORX® BRUNITE

| FEWEC articolo | Torx | A x B mm | |
|-------------------|--------|-------------|---|
| 600-T3 | TX 3 | 40 X 13 | 1 |
| 600-T4 | TX 4 | 40 X 13 | 1 |
| 600-T5 | TX 5 | 40 X 13 | 1 |
| 600-T6 | TX 6 | 40 X 13 | 1 |
| 600-T7 | TX 7 | 44 X 12 | 1 |
| 600-T8 | TX 8 | 46 X 14 | 1 |
| 600-T9 | TX 9 | 53 X 17 | 1 |
| 600-T10 | TX 10 | 56 X 20 | 1 |
| 600-T15 | TX 15 | 60 X 22 | 1 |
| 600-T20 | TX 20 | 64 X 23 | 1 |
| 600-T25 | TX 25 | 71 X 24 | 1 |
| 600-T27 | TX 27 | 75 X 24 | 1 |
| 600-T30 | TX 30 | 77 X 26 | 1 |
| 600-T40 | TX 40 | 82 X 29 | 1 |
| 600-T45 | TX 45 | 88 X 32 | 1 |
| 600-T50 | TX 50 | 103 X 38 | 1 |
| 600-T55 | TX 55 | 103 X 42 | 1 |
| 600-T60 | TX 60 | 125 X 45 | 1 |
| 600-T70 | TX 70 | 132 X 52 | 1 |
| 600-T80 | TX 80 | 150 X 58 | 1 |
| 600-T90 | TX 90 | 160 X 60 | 1 |
| 600-T100 | TX 100 | 170 X 65 | 1 |



SERIE 8 CHIAVI TORX® BRUNITE

| FEWEC articolo | Torx | |
|-------------------|------------------------------|---|
| 600-T-940 | TX 9-10-15-20 25-27-30-40 | 1 |



| BGS articolo | DESCRIZIONE |
|-----------------|---|
| BGS 7959 | SET 9 PEZZI, CHIAVI MASCHIO TORX PIEGATE, TX10 - TX50 |

CARATTERISTICHE

- Torx: TX10 - TX15 - TX20 - TX25 - TX27 - TX30 - TX40 - TX45 - TX50
- finitura nera
- in cassetta di plastica
- peso 280 g



SERIE 8 CHIAVI SATINATE CHROM VANADIUM TORX® ESPOSITORE 12 PEZZI A RICHIESTA

| FEWEC articolo | Torx | |
|-------------------|----------------------------|---|
| 603-1050 | 10-15-20-25-30 40-45-50 | 1 |

RICAMBI

| FEWEC articolo | Torx | A x B mm | |
|-------------------|-------|-------------|---|
| 603-T10 | TX 10 | 56 X 20 | 1 |
| 603-T15 | TX 15 | 60 X 22 | 1 |
| 603-T20 | TX 20 | 64 X 23 | 1 |
| 603-T25 | TX 25 | 71 X 24 | 1 |
| 603-T30 | TX 30 | 77 X 26 | 1 |
| 603-T40 | TX 40 | 82 X 29 | 1 |
| 603-T45 | TX 45 | 88 X 32 | 1 |
| 603-T50 | TX 50 | 103 X 38 | 1 |

GERMANY

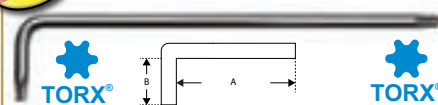

CHIAVI TORX® NICHELATE - TIPO LUNGO

| FEWEC articolo | Torx | A x B mm | |
|-------------------|-------|-------------|---|
| 6060-T10 | TX 10 | 90 X 15 | 1 |
| 6060-T15 | TX 15 | 100 X 18 | 1 |
| 6060-T20 | TX 20 | 112 X 18 | 1 |
| 6060-T25 | TX 25 | 128 X 22 | 1 |
| 6060-T27 | TX 27 | 140 X 25 | 1 |
| 6060-T30 | TX 30 | 160 X 28 | 1 |
| 6060-T40 | TX 40 | 180 X 32 | 1 |
| 6060-T45 | TX 45 | 200 X 38 | 1 |
| 6060-T50 | TX 50 | 225 X 40 | 1 |



SERIE 9 CHIAVI TORX® NICHELATE TIPO LUNGO

| FEWEC articolo | Torx | | €uro |
|-------------------|----------------------------------|---|------|
| 6060-CLIP-1050 | TX 10-15-20-25 27-30-40-45-50 | 1 | |



TORX®  

| | |
|--|--|
| BGS articolo | DESCRIZIONE |
| BGS 816 | SERIE 9 PEZZI, CHIAVI MASCHIO TORX PIEGATE, TX10 - TX50 |
| CARATTERISTICHE | |
| <ul style="list-style-type: none"> • Torx: TX10 - TX15 - TX20 - TX25 - TX27 - TX30 - TX40 - TX45 - TX50 • tipo lungo, lunghezza fino a 185 mm • su supporto in plastica • peso 370 g | |



TORX®

SERIE 8 CHIAVI TORX® BRUNITE STRUTTURA IN ACCIAIO

| | | |
|------------------|--------------------------------------|----------|
| articolo | mm | 1 |
| 600-H-940 | TX 9-10-15-20 25-27-30-40 | 1 |



TORX®

MINI CHIAVI TORX® - IMPUGNATURA A BANDIERA

| | | |
|-----------------|--------------|-----------|
| articolo | mm | 1 |
| 640-0005 | TX 5 | 90 |
| 640-0006 | TX 6 | 90 |
| 640-0007 | TX 7 | 90 |
| 640-0008 | TX 8 | 90 |
| 640-0009 | TX 9 | 90 |
| 640-0010 | TX 10 | 90 |
| 640-0015 | TX 15 | 95 |
| 640-0020 | TX 20 | 95 |



TORX®

SERIE 8 CHIAVI SATINATE TORX® + GANCIO STRUTTURA IN ACCIAIO E RIVESTIMENTO IN PLASTICA ANTISCIVOLO

| | | |
|-----------------|--------------------------------------|----------|
| articolo | mm | 1 |
| 61940 | TX 8-10-15-20 25-27-30-40 | 1 |



TORX®

SERIE 8 MINI CHIAVI TORX® IN CUSTODIA SIMILPELLE

| | | |
|-------------------|----------------------------------|----------|
| articolo | mm | 1 |
| 640-RO-520 | TX 5-6-7-8-9 10-15-20 | 1 |

XXL **LUNGHEZZA 600 MM**



lunghezza 600 mm

TORX®

SERIE 6 CHIAVI TORX SATINATE TIPO EXTRA LUNGO LUNGHEZZA: 600 MM

| | | | |
|-----------------|---------------------------------|----------|-------------|
| articolo | TX | 1 | €uro |
| 79600 | TX 20-25-30 40-45-50 | 1 | |



TORX®  

| | |
|--|--|
| BGS articolo | DESCRIZIONE |
| BGS 7848 | SERIE CHIAVI MASCHIO TORX, TX6 - TX20 |
| CARATTERISTICHE | |
| <ul style="list-style-type: none"> • misure: TX6 - TX7 - TX8 - TX9 - TX10 - TX15 - TX20 • struttura in alluminio anodizzato blu • chiavi cromate satinare • dimensioni: 97 x 32 x 13 mm • peso 80 g | |



TORX®

SERIE 12 CALIBRI IN PLASTICA PER MISURARE LA DIMENSIONE DELLE IMPRONTE DELLE VITI TORX®

| | | |
|-----------------|---|----------|
| articolo | mm | 1 |
| 61060 | TX 10-TX 60 MASCHIO E 6-E 16 FEMMINA | 1 |

CHIAVI MASCHIO



| | |
|-----------------|---|
| BGS articolo | DESCRIZIONE |
| | SERIE 9 PEZZI, CHIAVI TORX CON FORO, TH10 - TH50 |

| | |
|--|--|
| CARATTERISTICHE | |
| <ul style="list-style-type: none"> • estremità nere sul lato lungo • tipo corto • qualità premium • misure: TH/TX 10 - 15 - 20 - 25 - 27 - 30 - 40 - 45 - 50 • peso 290 g | |



| | |
|-----------------|---|
| BGS articolo | DESCRIZIONE |
| | SERIE 9 PEZZI, CHIAVI TORX TX10 - TX50 |

| | |
|---|--|
| CARATTERISTICHE | |
| <ul style="list-style-type: none"> • Torx con foro sul lato lungo • tipo lungo • estremità nere sul lato lungo • misure: TH/TX 10 - 15 - 20 - 25 - 27 - 30 - 40 - 45 - 50 • fornite in supporto con clip • peso 430 g | |

| | | | |
|-----------------|-------|-------|---|
| RICAMBI | | | |
| BGS articolo | | | |
| BGS 794-T10 | TX 10 | TH 10 | 1 |
| BGS 794-T15 | TX 15 | TH 15 | 1 |
| BGS 794-T20 | TX 20 | TH 20 | 1 |
| BGS 794-T25 | TX 25 | TH 25 | 1 |
| BGS 794-T27 | TX 27 | TH 27 | 1 |
| BGS 794-T30 | TX 30 | TH 30 | 1 |
| BGS 794-T40 | TX 40 | TH 40 | 1 |
| BGS 794-T45 | TX 45 | TH 45 | 1 |
| BGS 794-T50 | TX 50 | TH 50 | 1 |



| | |
|-----------------|--|
| BGS articolo | DESCRIZIONE |
| | SERIE 9 CHIAVI TORX® TIPO EXTRA LUNGO SATINATE C/FORO NELLA PUNTA BRUNITA |



| | |
|-----------------|---|
| BGS articolo | DESCRIZIONE |
| | SERIE 9 CHIAVI TORX® CON ESTREMITÀ SFERICA SATINATE IN ACCIAIO S2 - TIPO LUNGO |

| | |
|-----------------|--|
| BGS articolo | DESCRIZIONE |
| | SERIE 9 PEZZI, CHIAVI TORX CON ESTREMITÀ SFERICA, TIPO LUNGO, TX10 - TX50 |

| | |
|--|--|
| CARATTERISTICHE | |
| <ul style="list-style-type: none"> • testa sferica sul lato lungo • tipo lungo • permette di lavorare fino a 25° • misure (lunghezza lato corto x lunghezza lato lungo): TX10 20 x 89.5 mm - TX15 21.5 x 94 mm TX20 23 x 99 mm - TX25 24.5 x 104.5 mm TX27 26 x 112.5 mm - TX30 30 x 121 mm TX40 33 x 133 mm - TX45 38 x 141 mm TX50 41 x 159 mm • peso 314 g | |



| | |
|-----------------|--|
| BGS articolo | DESCRIZIONE |
| | SERIE 9 PEZZI, CHIAVI TORX CON ESTREMITÀ SFERICA, TIPO CORTO, TX10 - TX50 |

| | |
|--|--|
| CARATTERISTICHE | |
| <ul style="list-style-type: none"> • testa sferica sul lato lungo • tipo corto • permette di lavorare fino a 25° • misure (lunghezza lato corto x lunghezza lato lungo): TX10 20 x 89.5 mm - TX15 21.5 x 94 mm TX20 23 x 99 mm - TX25 24.5 x 104.5 mm TX27 26 x 112.5 mm - TX30 30 x 121 mm TX40 33 x 133 mm - TX45 38 x 141 mm TX50 41 x 159 mm • peso 314 g | |



| | |
|-----------------|--|
| BGS articolo | DESCRIZIONE |
| | SERIE 9 PEZZI, CHIAVI TORX CON ESTREMITÀ SFERICA, TIPO LUNGO, TX10 - TX50 |

| | |
|--|--|
| CARATTERISTICHE | |
| <ul style="list-style-type: none"> • testa sferica sul lato lungo • tipo lungo • permette di lavorare fino a 25° • misure (lunghezza lato corto x lunghezza lato lungo): TX10 20 x 89.5 mm - TX15 21.5 x 94 mm TX20 23 x 99 mm - TX25 24.5 x 104.5 mm TX27 26 x 112.5 mm - TX30 30 x 121 mm TX40 33 x 133 mm - TX45 38 x 141 mm TX50 41 x 159 mm • peso 436 g | |







TORX®
CON FORO







TORX®



SERIE 9 CHIAVI TORX® TIPO EXTRA LUNGO
CON MAGNETE ALLOGGIATO NEL LATO
LUNGO - RIVESTIMENTO ANTISCIVOLO

| | | | |
|--|---|---|---|
|  |  |  |  |
| articolo | TX | TH | |
| 96950 | TX/TH 10-15-20 | | 1 |
| | 25-27-30-40-45-50 | | |

RICAMBI

| | | | | |
|--|---|---|---|---|
|  |  |  |  |  |
| articolo | | | | |
| 96950-10 | TX 10 | TH 10 | | 1 |
| 96950-15 | TX 15 | TH 15 | | 1 |
| 96950-20 | TX 20 | TH 20 | | 1 |
| 96950-25 | TX 25 | TH 25 | | 1 |
| 96950-27 | TX 27 | TH 27 | | 1 |
| 96950-30 | TX 30 | TH 30 | | 1 |
| 96950-40 | TX 40 | TH 40 | | 1 |
| 96950-45 | TX 45 | TH 45 | | 1 |
| 96950-50 | TX 50 | TH 50 | | 1 |



art. 32519

art. 96950

ESAGONO



TORX®

TORX®
CON FORO



| | |
|---|---|
|  | DESCRIZIONE |
| articolo | ESPOSITORE 10 SERIE, CHIAVI ESAGONALI E TORX COLORATE MAGNETICHE |
| 325950 | |

CARATTERISTICHE

- espositore composto da:
 - 5 serie di chiavi esagonali magnetiche art. 32519
 - 5 serie di chiavi Torx magnetiche art. 96950





XXL
LATO EXTRA CORTO

LATO EXTRA CORTO PER SPAZI RISTRETTI

TORX®
PRO+
CV S2

BGS
articolo

BGS 9375

DESCRIZIONE

SERIE 9 PEZZI, CHIAVI MASCHIO TORX PIEGATE EXTRA-LUNGHE, LATO CORTO EXTRA-CORTO, TX10-TX50

CARATTERISTICHE

- dimensioni (misura x lunghezza):
 - TX10 17 x 90 mm - TX15 18 x 100 mm
 - TX20 20 x 110 mm - TX25 21 x 130 mm
 - TX27 23 x 140 mm - TX30 27 x 160 mm
 - TX40 29 x 185 mm - TX45 33 x 205 mm
 - TX50 39 x 230 mm
- finitura satinata cromata
- con lato corto extra-corto
- con custodia pieghevole in plastica blu/nera
- peso 460 g

TORX®

PRO+
CV

BGS
articolo

BGS 793

DESCRIZIONE

SERIE 9 PEZZI, CHIAVI TORX, TX10 - TX50

CARATTERISTICHE

- tipo extra-lungo
- Torx: TX 10-15-20-25-27-30-40-45-50
- fornite in supporto con clip
- peso 430 g

NEW

TORX® CON FORO

TESTA SFERICA

CV
ESAGONO
TORX® CON FORO

BGS
articolo

BGS 822

DESCRIZIONE

SERIE 18 PEZZI, CHIAVI A L, ESAGONALI E TORX CON FORO

CARATTERISTICHE

- su due supporti pieghevoli
- chiavi a L Esagonali, con testa sferica sul lato lungo:
 - 1,5 mm (15 x 90 mm); 2 mm (17 x 100 mm)
 - 2,5 mm (20 x 110 mm); 3 mm (22 x 127 mm)
 - 4 mm (28 x 140 mm); 5 mm (32 x 160 mm)
 - 6 mm (36 x 183 mm); 8 mm (40 x 203 mm)
 - 10 mm (48 x 230 mm)
- chiavi a L Torx con Foro (su entrambe le estremità):
 - TH10 (18 x 52 mm); TH15 (19 x 58 mm);
 - TH20 (22 x 62 mm); TH25 (26 x 68 mm);
 - TH27 (30 x 76 mm); TH30 (32 x 82 mm);
 - TH40 (36 x 92 mm); TH45 (42 x 106 mm);
 - TH50 (46 x 118 mm)
- peso 700 g

TORX®

TORX®

TORX®

TORX®

CHIAVI A "T" 3 TESTE TORX® CON ASTA SCORREVOLE CHROM-VANADIUM

| FEARMEC articolo | | L mm | |
|------------------|--------------|------|---|
| 682-T9 | TX 9 | 125 | 1 |
| 682-T10 | TX 10 | 125 | 1 |
| 682-T15 | TX 15 | 125 | 1 |
| 682-T20 | TX 20 | 125 | 1 |
| 682-T25 | TX 25 | 180 | 1 |
| 682-T27 | TX 27 | 180 | 1 |
| 682-T30 | TX 30 | 180 | 1 |
| 682-T40 | TX 40 | 210 | 1 |
| 682-T45 | TX 45 | 210 | 1 |
| 682-T50 | TX 50 | 215 | 1 |

FEARMEC

TORX®

ASSORTIMENTO 7 PEZZI CHIAVI A "T" 3 TESTE TORX® CON ASTA SCORREVOLE CHROM-VANADIUM

| FEARMEC articolo | | | |
|------------------|-----------------------|-----------------|---|
| 682-1040 | TX 10-15-20-25 | 27-30-40 | 1 |

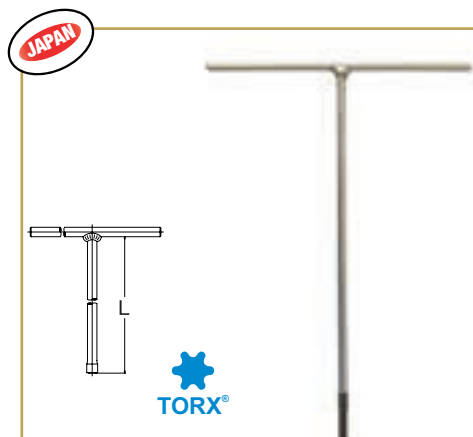

CHIAVI A "T" TORX® TIPO LUNGO CROMATE

| <i>Koken</i> articolo | Torx | L mm | |
|--------------------------|-------|---------|---|
| 157-T25 | TX 25 | 250 | 1 |
| 157-T27 | TX 27 | 250 | 1 |
| 157-T30 | TX 30 | 250 | 1 |
| 157-T40 | TX 40 | 250 | 1 |
| 157-T45 | TX 45 | 250 | 1 |
| 157-T50 | TX 50 | 250 | 1 |



CHIAVI A "T" SNODATE TORX MASCHIO LUNGHEZZA 500 MM

| <i>FERMEC</i> articolo | Torx | L mm | |
|---------------------------|-------|---------|---|
| 560-T20 | TX 20 | 500 | 1 |
| 560-T25 | TX 25 | 500 | 1 |
| 560-T27 | TX 27 | 500 | 1 |
| 560-T30 | TX 30 | 500 | 1 |
| 560-T40 | TX 40 | 500 | 1 |
| 560-T45 | TX 45 | 500 | 1 |
| 560-T50 | TX 50 | 500 | 1 |



CHIAVI TORX CON IMPUGNATURA A "T"

| <i>BGS</i> articolo | Torx | L mm |
|------------------------|-------|---------|
| BGS 4010-10 | TX 10 | 100 |
| BGS 4010-11 | TX 15 | 115 |
| BGS 4010-12 | TX 20 | 120 |
| BGS 4010-13 | TX 25 | 130 |
| BGS 4010-14 | TX 27 | 140 |
| BGS 4010-15 | TX 30 | 150 |
| BGS 4010-16 | TX 40 | 160 |
| BGS 4010-17 | TX 45 | 175 |
| BGS 4010-18 | TX 50 | 200 |



CHIAVI A "T" TORX® EXTRA LUNGHE JUMBO BRUNITE

| <i>FERMEC</i> articolo | Torx | L mm | |
|---------------------------|-------|---------|---|
| 7700-T10 | TX 10 | 450 | 1 |
| 7700-T15 | TX 15 | 450 | 1 |
| 7700-T20 | TX 20 | 450 | 1 |
| 7700-T25 | TX 25 | 450 | 1 |
| 7700-T27 | TX 27 | 450 | 1 |
| 7700-T30 | TX 30 | 450 | 1 |
| 7700-T40 | TX 40 | 450 | 1 |



CHIAVI TORX® PIEGATE CON IMPUGNATURA ERGONOMICA

| <i>FERMEC</i> articolo | Torx | L mm | |
|---------------------------|-------|----------|---|
| 605-6 | TX 6 | 90 X 12 | 1 |
| 605-7 | TX 7 | 90 X 12 | 1 |
| 605-8 | TX 8 | 90 X 12 | 1 |
| 605-9 | TX 9 | 90 X 12 | 1 |
| 605-10 | TX 10 | 90 X 12 | 1 |
| 605-15 | TX 15 | 90 X 12 | 1 |
| 605-20 | TX 20 | 130 X 15 | 1 |
| 605-25 | TX 25 | 130 X 15 | 1 |
| 605-27 | TX 27 | 130 X 15 | 1 |
| 605-30 | TX 30 | 175 X 12 | 1 |
| 605-40 | TX 40 | 175 X 12 | 1 |
| 605-45 | TX 45 | 175 X 12 | 1 |
| 605-50 | TX 50 | 175 X 12 | 1 |



| <i>BGS</i> articolo | DESCRIZIONE |
|------------------------|--|
| BGS 8485 | SET 9 PEZZI CHIAVI TORX PIEGATE CON IMPUGNATURA, TX10 - TX50 |

CARATTERISTICHE

- contenuto: TX10 x 100 mm; TX15 x 115 mm, TX20 x 120 mm, TX25 x 130 mm, TX27 x 140 mm, TX30 x 150 mm, TX40 x 160 mm, TX45 x 175 mm, TX50 x 200 mm
- impugnatura ergonomiche in materiale bi-componente
- su supporto in metallo
- peso 1,3 kg

CHIAVI MASCHIO



TORX®
CON FORO

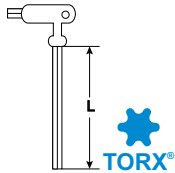

CHIAVI TORX® PIEGATE C/FORO SUL LATO CORTO ED IMPUGNATURA ANTISCIVOLO "ALTA RESISTENZA"

| FEARMEC articolo | TX | TH | L mm | |
|------------------|----|----|------|---|
| 8605-10 | 10 | | 100 | 1 |
| 8605-15 | 15 | | 100 | 1 |
| 8605-20 | 20 | | 100 | 1 |
| 8605-25 | 25 | | 150 | 1 |
| 8605-27 | 27 | | 150 | 1 |
| 8605-30 | 30 | | 150 | 1 |
| 8605-40 | 40 | | 200 | 1 |
| 8605-45 | 45 | | 200 | 1 |
| 8605-50 | 50 | | 200 | 1 |
| 8605-55 | 55 | | 200 | 1 |

TORX®
CON FORO



SERIE 10 CHIAVI TORX® PIEGATE IN VALIGETTA PLASTICA

| FEARMEC articolo | TX | TH | |
|------------------|----------------|----------------|---|
| 8606 | 10-15-20-25-27 | 30-40-45-50-55 | 1 |

TORX®
CON FORO

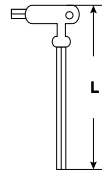

| BGSTECHNICO articolo | TX | L mm | |
|----------------------|-------|------|---|
| BCS 7880-T10 | TX 10 | 145 | 1 |
| BCS 7880-T15 | TX 15 | 145 | 1 |
| BCS 7880-T20 | TX 20 | 145 | 1 |
| BCS 7880-T25 | TX 25 | 210 | 1 |
| BCS 7880-T27 | TX 27 | 215 | 1 |
| BCS 7880-T30 | TX 30 | 215 | 1 |
| BCS 7880-T40 | TX 40 | 220 | 1 |
| BCS 7880-T45 | TX 45 | 275 | 1 |
| BCS 7880-T50 | TX 50 | 280 | 1 |

CARATTERISTICHE

- finitura nera
- estremità corta con FORO
- impugnatura in materiale bi-componente



TORX®
CON FORO

| BGSTECHNICO articolo | DESCRIZIONE |
|----------------------|--|
| BCS 7880 | SET 9 PEZZI, CHIAVI TORX CON IMPUGNATURA TX10 - TX50 |

CARATTERISTICHE

- lame con finitura nera
- estremità corte con FORO
- contenuto (TH/TX): T10x145 mm - T15x145 mm - T20x145 mm - T25x210 mm - T27x215 mm - T30x215 mm - T40x220 mm - T45x275 mm - T50x280 mm
- peso 1,7 kg

RICAMBI

| BGSTECHNICO articolo | DESCRIZIONE |
|----------------------|--|
| BCS 7880-LEER | CASSETTA VUOTA PER BGS 7880 E BGS 7882 |



TORX®
CON FORO

| BGSTECHNICO articolo | DESCRIZIONE |
|----------------------|---|
| BGS 7830 | SET 6 PEZZI, CHIAVI TORX CON IMPUGNATURA, TX10 - TX40 |

CARATTERISTICHE

- finitura satinata cromata con punta nera sul braccio lungo
- estremità corta con FORO
- Torx TX/TH: TX10 - TX15 - TX20 - TX25 - TX30 - TX40
- peso 410 g



TORX®
CACCIAVITI TORX® EXTRA LUNGI CON IMPUGNATURA A "T"

| FEARMEC articolo | TX | L mm | |
|------------------|-------|------|---|
| 6600-T10 | TX 10 | 300 | 1 |
| 6600-T15 | TX 15 | 300 | 1 |
| 6600-T20 | TX 20 | 300 | 1 |
| 6600-T25 | TX 25 | 300 | 1 |
| 6600-T27 | TX 27 | 300 | 1 |
| 6600-T30 | TX 30 | 300 | 1 |
| 6600-T40 | TX 40 | 300 | 1 |

Torx C/foro

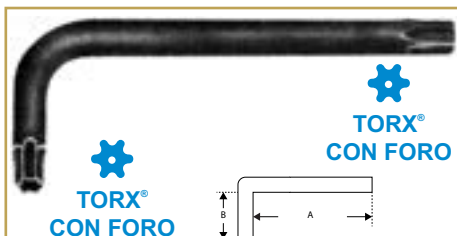
**TORX®
CON FORO**
**TORX®
CON FORO**
CHIAVI TORX® CON FORO BRUNITE

| FEIMEC articolo | TORX® | A x B mm |  |
|-----------------|--------|----------|---|
| 606 | TH 6 | 40 X 13 | 1 |
| 607 | TH 7 | 44 X 12 | 1 |
| 608 | TH 8 | 46 X 14 | 1 |
| 609 | TH 9 | 53 X 17 | 1 |
| 610 | TH 10 | 56 X 20 | 1 |
| 615 | TH 15 | 60 X 22 | 1 |
| 620 | TH 20 | 64 X 23 | 1 |
| 625 | TH 25 | 71 X 24 | 1 |
| 627 | TH 27 | 75 X 40 | 1 |
| 630 | TH 30 | 77 X 26 | 1 |
| 640 | TH 40 | 82 X 29 | 1 |
| 645 | TH 45 | 88 X 32 | 1 |
| 650 | TH 50 | 103 X 38 | 1 |
| 655 | TH 55 | 103 X 42 | 1 |
| 660 | TH 60 | 125 X 45 | 1 |
| 670 | TH 70 | 132 X 52 | 1 |
| 680 | TH 80 | 150 X 58 | 1 |
| 690 | TH 90 | 160 X 60 | 1 |
| 6100 | TH 100 | 170 X 65 | 1 |



**TORX®
CON FORO**
**TORX®
CON FORO**
**CHIAVI TORX® CON FORO NICHELATE
TIPO LUNGO**

| FEIMEC articolo | TORX® | A x B mm |  |
|-----------------|-------|----------|---|
| 6065-T10 | TH 10 | 90 X 15 | 1 |
| 6065-T15 | TH 15 | 100 X 18 | 1 |
| 6065-T20 | TH 20 | 112 X 18 | 1 |
| 6065-T25 | TH 25 | 128 X 22 | 1 |
| 6065-T27 | TH 27 | 140 X 25 | 1 |
| 6065-T30 | TH 30 | 160 X 28 | 1 |
| 6065-T40 | TH 40 | 180 X 32 | 1 |
| 6065-T45 | TH 45 | 200 X 38 | 1 |
| 6065-T50 | TH 50 | 225 X 40 | 1 |

**TORX®
CON FORO**
**SERIE 8 CHIAVI SATINATE TORX® C/FORO
+ GANCIO - STRUTTURA IN ACCIAIO E
RIVESTIMENTO IN PLASTICA ANTISCIVOLO**

| FEIMEC articolo | TORX® |  |
|-----------------|------------------------------|---|
| 81940 | TH 8-10-15-20-25 27-30-40 | 1 |

**TORX®
CON FORO**
**SERIE 8 CHIAVI TORX® C/FORO
STRUTTURA IN ACCIAIO
LUNGH. IMPUGNATURA MM 135**

| FEIMEC articolo | TORX® |  |
|-----------------|-------------------------------|---|
| 610-H-1045 | TH 10-15-20-25 27-30-40-45 | 1 |



**TORX®
CON FORO**
**TORX®
CON FORO**
**SERIE 9 CHIAVI TORX® CON FORO
NICHELATE - TIPO LUNGO**

| FEIMEC articolo | TORX® |  |
|-----------------|----------------------------------|---|
| 6065-CLIP-1050 | TH 10-15-20-25 27-30-40-45-50 | 1 |

**TORX®
CON FORO**
**TORX®
CON FORO**
SERIE 8 CHIAVI TORX® CON FORO BRUNITE

| FEIMEC articolo | TORX® |  |
|-----------------|------------------------------|---|
| 601-T-940 | TH 9-10-15-20-25 27-30-40 | 1 |

**TORX®
CON FORO**
SERIE 8 CHIAVI TORX® C/FORO

| FEIMEC articolo | TORX® |  |
|-----------------|------------------------------|---|
| 601-R-940 | TH 9-10-15-20 25-27-30-40 | 1 |



**TORX®
CON FORO**



**TORX®
CON FORO**

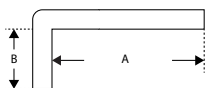

**SERIE 8 CHIAVI SATINATE CHROM
VANADIUM TORX® C/FORO
ESPOSITORE 12 PEZZI A RICHIESTA**

| articolo | | | |
|----------|-------------------------------|-------------|---|
| 903-5010 | TH 10-15-20-25-30 40-45-50 | 1 | |
| RICAMBI | | | |
| articolo | | A x B mm | |
| 903-TH10 | TH 10 | 56 X 20 | 1 |
| 903-TH15 | TH 15 | 60 X 22 | 1 |
| 903-TH20 | TH 20 | 64 X 23 | 1 |
| 903-TH25 | TH 25 | 71 X 24 | 1 |
| 903-TH30 | TH 30 | 77 X 26 | 1 |
| 903-TH40 | TH 40 | 82 X 29 | 1 |
| 903-TH45 | TH 45 | 88 X 32 | 1 |
| 903-TH50 | TH 50 | 103 X 38 | 1 |



**TORX®
TORX® CON FORO 1/4"-1/2"**

| FEEMEC articolo | DESCRIZIONE |
|--------------------|---|
| 2271 | SET 72 PEZZI, UTENSILI TORX ATT. 1/4" + 1/2" |

| CARATTERISTICHE |
|--|
| <ul style="list-style-type: none"> • bussole torx femmina: - att. 1/4": E4 - E5 - E6 - E7 - E8 - E10 - E11 - att. 1/2": E12 - E14 - E16 - E18 - E20 - E22 - E24 • chiavi a bussola Torx, att. 1/4": TX10 - TX15 - TX20 - TX25 - TX27 - TX30 • inserti att. 10 mm, lunghezza 30 mm, Torx c/ foro: TH40 - TH45 - TH50 - TH55 - TH60 - TH70 • inserti att. 10 mm, lunghezza 75 mm, Torx: TX15 TX20 - TX25 - TX30 - TX40 - TX45 - TX50 - TX55 - TX60 • inserti att. 1/4", lunghezza 25 mm: - Torx: TX7 - TX8 - TX9 - Torx con foro: TH10 - TH15 - TH20 - TH25 - TH27 - TH30 - TH40 • Chiave Torx tipo L: TX8 - TX10 - TX15 - TX20 - TX25 TX27 - TX30 - TX40 - TX45 - TX50 - TX55 - TX60 • cacciaviti Torx: TX8 - TX10 - TX15 - TX20 - TX25 TX27 - TX30 - TX40 • chiavi doppio anello: E6 x E8 - E10 x E12 - E14 x E18 E20 x E24 • adattatori - portainseriti esag. fem. 1/4" - quadro fem. 1/4" - portainseriti esag. fem. 10 mm - quadro fem. 1/2" • utensile di raccolta magnetico |



**TORX®
TORX® CON FORO 1/4"-1/2"**

| BGS articolo | DESCRIZIONE |
|-----------------|---|
| BGS 7849 | SET 84 PEZZI, UTENSILI TORX ATT. 1/4" + 1/2" |

| CARATTERISTICHE |
|---|
| <ul style="list-style-type: none"> • bussole att. 1/2": E12 - E14 - E16 - E18 - E20 - E22 - E24 • bussole att. 1/4": E4 - E5 - E6 - E7 - E8 - E10 - E11 • chiavi a bussola Torx, att. 1/4", lunghezza 37 mm: TX10 - TX15 - TX20 - TX25 - TX27 - TX30 • inserti att. 10 mm, lunghezza 30 mm, Torx con foro: TH40 - TH45 - TH50 - TH55 - TH60 - TH70 • inserti att. 10 mm, lunghezza 75 mm, Torx: TX15 - TX20 - TX25 - TX30 - TX40 - TX45 - TX50 • inserti att. 14 mm, lunghezza 75 mm, Torx: TX55 - TX60 • inserti att. 1/4", lunghezza 25 mm, 5 punte con foro: TS7 - TS8 - TS9 • inserti att. 1/4" mm, lunghezza 25 mm, Torx con foro: TH10 - TH15 - TH20 - TH25 - TH27 - TH30 - TH40 • Chiave Torx tipo L: TX8 - TX10 - TX15 - TX20 - TX25 TX27 - TX30 - TX40 - TX45 - TX50 - TX55 - TX60 • chiavi doppio anello: E6 x E8, E10 x E12, E14 x E18, E20 x E24 • cacciavite Torx con foro: TH8 - TH10 - TH15 - TH20 - TH25 - TH27 - TH30 - TH40 • inserti Torx in custodia di plastica, Torx con foro: TX10 - TX15 - TX20 - TX25 - TX27 - TX30 - TX40 - TX45 • inserti att. 14 mm, lunghezza 40 mm, Torx con foro: TX80 - TX90 - TX100 • adatt. portainseriti att. 1/4", att. quadro 1/4" • adatt. portainseriti att. quadro 1/2": 10 e 14 mm • utensile di raccolta magnetico • peso 4,3 kg |



RIBE®

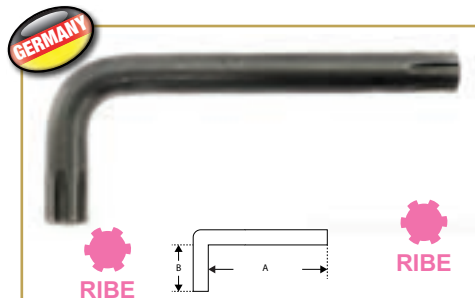

CHIAVI RIBE®

| FEEMEC articolo | M | A x B mm | |
|-----------------|------|----------|---|
| 6030-0004 | M 4 | 63 X 20 | 1 |
| 6030-0005 | M 5 | 72 X 25 | 1 |
| 6030-0006 | M 6 | 80 X 28 | 1 |
| 6030-0008 | M 8 | 90 X 32 | 1 |
| 6030-0010 | M 10 | 100 X 36 | 1 |
| 6030-0012 | M 12 | 112 X 40 | 1 |
| 6030-0014 | M 14 | 125 X 45 | 1 |
| 6030-0016 | M 16 | 140 X 55 | 1 |
| 6030-0018 | M 18 | 150 X 58 | 1 |
| 6030-0020 | M 20 | 160 X 60 | 1 |

XZN® Poligonale

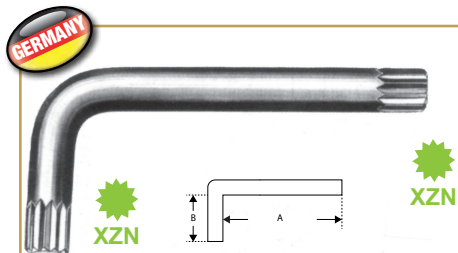

CHIAVI XZN® PIEGATE BRUNITE

| FEEMEC articolo | M | A x B mm | |
|-----------------|------|----------|---|
| 200-004 | M 4 | 63 X 20 | 1 |
| 200-005 | M 5 | 72 X 25 | 1 |
| 200-006 | M 6 | 80 X 28 | 1 |
| 200-008 | M 8 | 90 X 32 | 1 |
| 200-010 | M 10 | 100 X 36 | 1 |
| 200-012 | M 12 | 112 X 40 | 1 |
| 200-014 | M 14 | 125 X 45 | 1 |
| 200-016 | M 16 | 140 X 55 | 1 |
| 200-018 | M 18 | 140 X 55 | 1 |

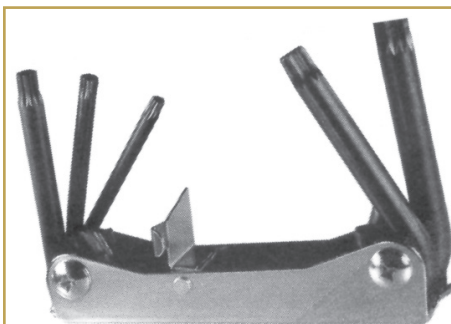

SERIE 5 CHIAVI XZN STRUTTURA IN ACCIAIO

| FEEMEC articolo | M | | |
|-----------------|---------------|--|---|
| 200-H-512 | M 5-6-8-10-12 | | 1 |

Pentalobati con foro



PENTALOBATO CON FORO

PENTALOBATA CON FORO **PRO+** **CV**

| BGS articolo | DESCRIZIONE |
|--------------|---|
| BGS 777 | SERIE 9 PEZZI, CHIAVI PENTALOBATE 5 PUNTE CON FORO, TP10 - TP50 |

CARATTERISTICHE

- finitura satinata
- extra-lunghe (fino a 235 mm), con foro
- misure: TP10 - TP15 - TP20 - TP25 - TP27 - TP30 - TP40 - TP45 - TP50
- peso 460 g

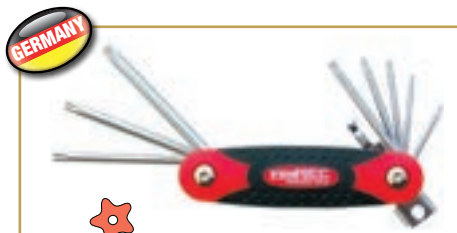

PENTALOBATA CON FORO

SERIE 8 CHIAVI SATINATE 5 PUNTE C/FORO + GANCIO STRUTTURA IN ACCIAIO E RIVESTIMENTO IN PLASTICA ANTISCIVOLO

| FEEMEC articolo | | |
|-----------------|---------------------------|---|
| 91940 | TP 8-10-15-20-25-27-30-40 | 1 |



NOTE

A series of horizontal dotted lines for taking notes.