

ACCESSORI PER AVVITATORI

| | | | |
|-----|------------|--------------------------|---|
| PAG | 154 | PORTA INSERTI |  |
| PAG | 158 | PORTA INSERTI AD ANGOLO |  |
| PAG | 161 | BUSSOLE PORTA INSERTI |  |
| PAG | 164 | ADATTATORI PORTA BUSSOLE |  |
| PAG | 167 | ADATTATORI PER MANDRINI |  |
| PAG | 168 | MANDRINI |  |
| PAG | 170 | PORTAMASCHI |  |
| PAG | 172 | AVVITA PRIGIONIERI |  |
| PAG | 173 | AVVITA BUSSOLE FILETTATE |  |
| PAG | 173 | PORTA FILIERE |  |
| PAG | 174 | SPECIALI |  |

PORTA INSERTI MAGNETICI



ESAGONO 1/4" E

PORTA INSERTI CON MAGNETE EXTRA FORTE

attacco: DIN 3126, E 6,35

| articolo | Ø mm | L mm | CONFEZIONE |
|----------|-------------|------|------------|
| 15005 | 11 C/ANELLO | 58 | 5 |
| 15005 C | 11 C/ANELLO | 58 | 100 |
| 15007 | 10 S/ANELLO | 58 | 5 |
| 15009 | 10 C/ANELLO | 50 | 5 |



ESAGONO 1/4" E

PORTA INSERTI CON MAGNETE EXTRA FORTE

attacco: DIN 3126, E 6,35

| articolo | Ø mm | L mm | CONFEZIONE |
|-------------|-------------|------|------------|
| 10052.75 SA | 10 S/ANELLO | 75 | 5 |
| 10052.75 | 10 C/ANELLO | 75 | 5 |
| 10052.75 C | 10 C/ANELLO | 75 | 100 |
| 10052.100 | 10 C/ANELLO | 100 | 5 |
| 10052.120 | 10 C/ANELLO | 120 | 5 |
| 10052.150 | 10 C/ANELLO | 150 | 5 |
| 10052.180 | 10 C/ANELLO | 180 | 5 |
| 10052.200 | 10 C/ANELLO | 200 | 5 |
| 10052.250 | 10 C/ANELLO | 250 | 5 |
| 10052.300 | 10 C/ANELLO | 300 | 1 |
| 10052.400 | 10 C/ANELLO | 400 | 1 |
| 10052.500 | 10 C/ANELLO | 500 | 1 |



ESAGONO 1/4" E

PORTA INSERTI TIPO PESANTE CON SCARICO PER BUSSOLA DI GUIDA - MAGNETE EXTRA FORTE

attacco: DIN 3126, E 6,35

| articolo | Ø mm | L mm | CONFEZIONE |
|----------|-------------|------|------------|
| 10251 | 11 C/ANELLO | 60 | 5 |
| 10252 | 11 C/ANELLO | 75 | 5 |
| 10252 C | 11 C/ANELLO | 75 | 100 |



ESAGONO 1/4" E

PORTA INSERTI CON GHIERA PER BLOCCAGGIO INSERTI

attacco: DIN 3126, E 6,35

| articolo | Ø mm | L mm | CONFEZIONE |
|-----------|-------------|------|------------|
| 10051.60 | 10 C/ANELLO | 60 | 1 |
| 10051.120 | 10 C/ANELLO | 120 | 1 |



ESAGONO 1/4" E

PRO+ CV

BGS articolo

BGS 1729

DESCRIZIONE

PORTA INSERTI MAGNETICO LUNGHEZZA 60 MM

CARATTERISTICHE

- satinato
- idoneo per uso con avvitatori
- peso 20 g



ESAGONO 1/4" E

PRO+ CV

BGS articolo

BGS 1727

DESCRIZIONE

PORTA INSERTI MAGNETICO ALTA RESISTENZA LUNGHEZZA 60 MM

CARATTERISTICHE

- magneti extra forte che permette di trattenere le viti tramite l'inserto
- peso 30 g



ESAGONO 1/4" E

PORTA INSERTI INTEGRALE INOX PEZZO UNICO

attacco: DIN 3126, E 6,35

| articolo | Ø mm | L mm | CONFEZIONE |
|----------|-------------|------|------------|
| 115008 | 11 C/ANELLO | 60 | 5 |
| 115009 | 11 C/ANELLO | 75 | 5 |



ESAGONO 1/4" E

MINI PORTA INSERTI MAGNETICO SENZA ATTACCO 1/4"

- SI INSERISCE DIRETTAMENTE NEL MANDRINO DEL TRAPANO AVVITATORE DA 10 MM

- SI ELIMINA LA POSSIBILITÀ DI ROTTURA O IL DISTACCO DEL GAMBO ESAGONALE PER AVVITATORI AD IMPULSI - MASSA BATTENTE

Ø 9,8 mm

35 mm

| articolo | Ø mm | L mm | CONFEZIONE |
|----------|------|------|------------|
| 11150 | 9,8 | 35 | 5 |



ESAGONO 1/4" E

5/16"

PORTA INSERTI CON MAGNETE EXTRA FORTE

attacco: DIN 3126, E 6,35

| articolo | Ø mm | L mm | CONFEZIONE |
|----------|-------------|------|------------|
| 10253 | 13 C/ANELLO | 60 | 1 |

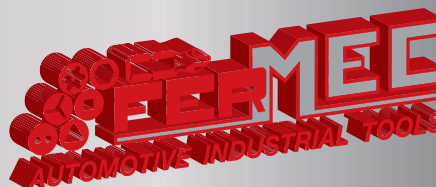

FLEX



ESAGONO 1/4" E

PORTA INSERTI CON MAGNETE EXTRA FORTE CON RIVESTIMENTO IN PLASTICA ANTIGRAFFIO

magnete extra forte

| FEEMEC articolo | ESAGONO | Ø mm | L mm | Immagine |
|-----------------|---------|-------------|------|----------|
| 10052 PL | 1/4" | 12 C/ANELLO | 75 | 1 |

FLEX



ESAGONO 1/4" C

PROLUNGA FLESSIBILE PORTA INSERTI NON MAGNETIZZATA

attacco: DIN 3126, E 6,35

| FEEMEC articolo | ESAGONO | L mm | Immagine |
|-----------------|---------|------|----------|
| 48500 | 1/4" | 190 | 1 |

FLEX



ESAGONO 1/4" E

PROLUNGA FLESSIBILE PORTA INSERTI MAGNETICA CON SGANCIO RAPIDO COPPIA MASSIMA 15 NM

attacco: DIN 3126, E 6,35

| FEEMEC articolo | ESAGONO | L mm | Immagine |
|-----------------|---------|------|----------|
| 48700 | 1/4" | 223 | 1 |

FLEX



ESAGONO 1/4" E

CV

BGS articolo

BGS 20804

DESCRIZIONE

SET 11 PEZZI, INSERTI E PROLUNGA PORTA-INSERTI FLESSIBILE

CARATTERISTICHE

- attacco esagonale 1/4"
- prolunga flessibile, 300 mm
- 6 inserti lunghezza 50 mm:
 - Taglio: 4,5 - 7 mm
 - PH: 1 - 2
 - PZ: 1 - 2
- 4 inserti lunghezza 75 mm:
 - PH: 1 - 2
 - PZ: 1 - 2
- peso 270 g

ESAGONO 1/4" E

pulsante di sgancio

PRO+ CV

BGS articolo

BGS 8477

DESCRIZIONE

PORTA INSERTI CON SGANCIO RAPIDO

CARATTERISTICHE

- extra sottile: Ø 11 mm
- lunghezza: 70 mm
- per inserti attacco 1/4"
- manicotto di attacco rapido in alluminio
- peso 40 g

ESAGONO 1/4" E

PORTA INSERTI SGANCIO RAPIDO

| FEEMEC articolo | ESAGONO | L mm | Immagine |
|-----------------|---------|------|----------|
| 10354 | 1/4" | 58 | 1 |
| 10354.75 | 1/4" | 75 | 1 |
| 10354.100 | 1/4" | 100 | 1 |
| 10354.150 | 1/4" | 150 | 1 |
| 10354.200 | 1/4" | 200 | 1 |
| 10354.300 | 1/4" | 300 | 1 |

CON CANOTTO



ESAGONO 1/4" E

PRO+

PORTA INSERTI CON SGANCIO RAPIDO

| BGS articolo | L mm |
|--------------|------|
| BGS 1734 | 80 |
| BGS 1735 | 150 |
| BGS 1736 | 300 |
| BGS 1724 | 450 |
| BGS 1723 | 600 |

CARATTERISTICHE

- l'asta ruota all'interno di un canotto in metallo rivestito in plastica, consentendo la presa del porta inserti durante il lavoro

NEW



ESAGONO 1/4" E

BGS articolo

BGS 20815

DESCRIZIONE

SET 2 PEZZI, PORTA-INSERTI A SGANCIO RAPIDO, ATT. 1/4", 60 & 150 MM

CARATTERISTICHE

- lunghezza: 60 e 150 mm

USH GERMANY

ESAGONO 1/4" E

PORTA INSERTI SGANCIO RAPIDO

| FEIMEC articolo | ESAGONO | L mm | ESPOSITORE |
|-----------------|---------------------|------|------------|
| 10350 | 1/4" | 51 | 5 |
| 10350 E | ESPOSITORE 24 PEZZI | | 1 |

USH GERMANY

ESAGONO 1/4" E

RAPID BIT

attacco: DIN 3126, D 6,35
impronta: DIN 3126, D 6,35
nota: **ABBASSANDO LA GHIERA DEL RAPID BIT UNA MOLLA POSTA ALL'INTERNO FACILITA L'ESPULSIONE DELL'INSERTO**

| FEIMEC articolo | ESAGONO | L mm | ESPOSITORE |
|-----------------|---------------------|------|------------|
| 10358 | 1/4" | 65 | 1 |
| 10358 E | ESPOSITORE 24 PEZZI | | 1 |

USH GERMANY

ESAGONO 1/4" E

PORTA INSERTI CON DOPPIO MAGNETE EXTRA FORTE CON REGOLAZIONE DI BATTUTA IDEALE PER CARTONGESSO E VITI EXTRA LUNGHE

attacco: DIN 3126, E 6,35

| FEIMEC articolo | ESAGONO | testa vite mm | L mm | ESPOSITORE |
|-----------------|---------------------|--------------------|------|------------|
| 17026 | 1/4" | DA 7,5 MM ED OLTRE | 60 | 5 |
| 17026 E | ESPOSITORE 24 PEZZI | | | 1 |

USH GERMANY

ESAGONO 1/4" E

PORTA INSERTI CON DOPPIO MAGNETE - IL MAGNETE DI TESTA SCORREVOLE BLOCCA AUTOMATICAMENTE LA VITE FINO AD AVVITAMENTO ULTIMATO

attacco: DIN 3126, E 6,35

| FEIMEC articolo | ESAGONO | testa vite mm | L mm | ESPOSITORE |
|-----------------|---------------------|---------------|------|------------|
| 10383 | 1/4" | 7,5/12MM | 65 | 5 |
| 10383 E | ESPOSITORE 24 PEZZI | | | 1 |

ESAGONO 1/4" E

PORTA INSERTI MAGNETICO CON REGOLAZIONE DI BATTUTA IDEALE PER CARTONGESSO

attacco: DIN 3126, E 6,35

| FEIMEC articolo | ESAGONO | L mm | ESPOSITORE |
|-----------------|---------|------|------------|
| 15020 | 1/4" | 72 | 1 |

DESOUTTER 5/16"

PORTA INSERTI TIPO DESOUTTER CON SCARICO PER BUSSOLA DI GUIDA

attacco: 5/16"

| FEIMEC articolo | ESAGONO | Ø mm | L mm | ESPOSITORE |
|-----------------|---------|-------------|------|------------|
| 10058 | 1/4" | 11 C/ANELLO | 55 | 1 |
| 10256 | 1/4" | 11 C/ANELLO | 70 | 1 |

DESOUTTER 5/16"

PORTA INSERTI TIPO DESOUTTER

attacco: 5/16"

| FEIMEC articolo | ESAGONO | L mm | ESPOSITORE |
|-----------------|---------|------|------------|
| 10356 | 1/4" | 70 | 1 |

SDS plus

MAGNETE EXTRA FORTE

attacco: SDS-plus

| FEIMEC articolo | ESAGONO | Ø mm | L mm | ESPOSITORE |
|-----------------|---------|---------------|------|------------|
| 10288 | 1/4" | 11.5 C/ANELLO | 78 | 1 |



PORTA INSERTI SDS-PLUS

attacco: SDS-plus

| FEWEC articolo | Ø mm | L mm | Box |
|----------------|------|------|-----|
| 10388 | 1/4" | 80 | 1 |



PORTA INSERTI TIPO FEIN

attacco: G 7

| FEWEC articolo | Ø mm | L mm | Box |
|----------------|------|--------------|------|
| 10263 | 1/4" | 9,5 C/ANELLO | 75 1 |
| 10264 | 1/4" | 11 C/ANELLO | 75 1 |



PORTA INSERTI TIPO FEIN

attacco: G 7

| FEWEC articolo | Ø mm | L mm | Box |
|----------------|------|------|-----|
| 10364 | 1/4" | 74 | 1 |



PORTA INSERTI TIPO BOSCH

attacco: DIN 3126, E 11,2

| FEWEC articolo | Ø mm | L mm | Box |
|----------------|-------|-------------|------|
| 10268 | 1/4" | 11 C/ANELLO | 80 1 |
| 10568 | 5/16" | 11 C/ANELLO | 75 1 |



PORTA INSERTO TIPO BOSCH

attacco: DIN 3126, A 5,5

| FEWEC articolo | Ø mm | L mm | Box |
|----------------|------|-------------|------|
| 10260 | 1/4" | 11 C/ANELLO | 72 1 |

PORTA INSERTI NON MAGNETICI



PORTA INSERTI 1/4"

attacco: DIN 3126, E 6,35

| FEWEC articolo | Ø mm | L mm | Box |
|----------------|------|-------------|------|
| 11001 | 1/4" | 11 C/ANELLO | 58 1 |



PORTA INSERTI IMPRONTA CON SGANCIO RAPIDO

attacco: DIN 3126, E 6,35

| FEWEC articolo | L mm | Box |
|----------------|------|-----|
| 11301 | 51 | 1 |



PORTA INSERTI SDS-PLUS

attacco: SDS-plus

| FEWEC articolo | Ø mm | L mm | Box |
|----------------|------|-------------|------|
| 11219 | 1/4" | 11 C/ANELLO | 75 1 |



BGS

| articolo | DESCRIZIONE |
|----------|--|
| BGS 1732 | PORTA INSERTI CON SGANCIO RAPIDO ATTACCO SDS |

CARATTERISTICHE

- lunghezza: 80 mm
- manicotto di attacco rapido in alluminio
- peso 60 g



DESOUTTER
5/16"

PORTA INSERTI TIPO DESOUTTER

attacco: 5/16"

| FEWEC articolo | Ø mm | L mm | Box |
|----------------|------|-------------|------|
| 11003 | 1/4" | 11 C/ANELLO | 57 1 |



3 mm

PORTA INSERTI - PER INSERTI 4 MM CON SFERA A RICHIESTA

attacco: DIN 3126, A 3

| FEWEC articolo | Ø mm | L mm | Box |
|----------------|------|------|------|
| 10088 | 4 mm | 6 | 57 1 |

PORTA INSERTI

PORTA INSERTI SNODATI

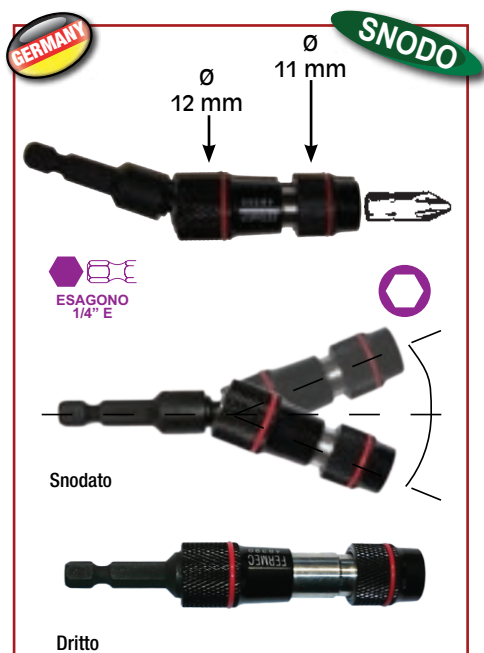

PORTA INSERTI SNODATO CON SGANCIO RAPIDO SNODATO FINO A 20° CON DOPPIA FUNZIONE: DRITTO E SNODATO



attacco: DIN 3126, E 6,35

| | | | | |
|----------|------|------|---|------|
| articolo | 1/4" | L mm | 1 | €uro |
| 48390 | | 90 | | |

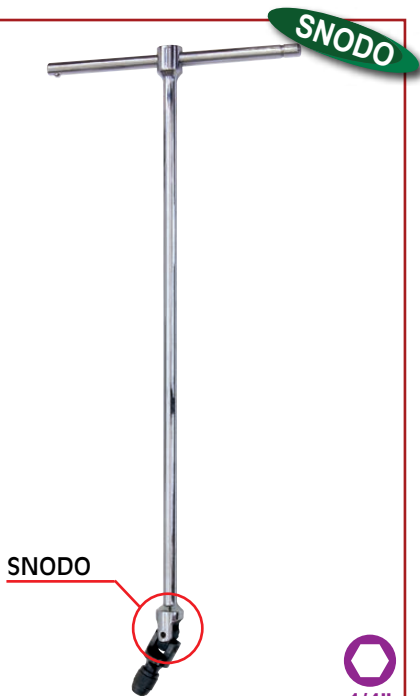

CHIAVE A "T" SNODATA CON MANDRINO PORTA INSERTI 1/4" ASTA SCORREVOLE - SGANCIO RAPIDO

| | | | |
|----------|------|------|---|
| articolo | 1/4" | L mm | 1 |
| 85414 | | 450 | |

PORTA INSERTI AD ANGOLO



| |
|--|
| DESCRIZIONE |
| MINI PORTA INSERTI AD ANGOLO MAGNETICO, LUNGHEZZA 37 MM |

- CARATTERISTICHE**
- attacco 1/4"
 - ideale per avvitiamenti in spazi ridotti
 - con magneti
 - peso 110 g



- CARATTERISTICHE**
- attacco da 1/4" esagonale
 - portainseri attacco da 1/4" esagonale femmina
 - lunghezza 310 mm
 - peso 330 g



RINVIO ANGOLARE 360° REGOLABILE DISASSATO PER AVVITARE IN TUTTE LE POSIZIONI

| | |
|-------------|-----------------|
| Descrizione | 1 |
| articolo | RINVIO ANGOLARE |
| 83600 | |



| |
|---|
| DESCRIZIONE |
| PORTA INSERTI AD ANGOLO 90° CON 7 INSERTI DOPPIA PUNTA, IN CUSTODIA CON GANCIO |

- CARATTERISTICHE**
- attacco 1/4"
 - 7 inserti doppia punta:
 - PZ 1-2-3, PH 1-2-3
 - Taglio: 4-5-6 mm
 - Esagonali: 4-5-6 mm
 - Torx: TX15, TX20
 - peso 130 g





ESAGONO 1/4" E

ESAGONO 1/4"

CV

| | |
|-----------------------------------|---|
| BGS tecnico articolo | DESCRIZIONE |
| BGS 20802 | SET 26 PEZZI, INSERTI BUSSOLE E PORTAININSERTI 90° |

CARATTERISTICHE

- per uso manuale
- 15 inserti att. 1/4":
 - Taglio 4-5-6 mm
 - PH 1-2-3
 - PZ 1-2-3
 - Esagonali 3-4-5 mm
 - Torx: TX15 - TX20 - TX25
 - 1 adattatore portabussole
- 9 bussole esagonali: 5 - 6 - 7 - 8 - 9 - 10 - 11 - 12 - 13 mm
- peso 350 g



Right Angle Attachment

ESAGONO 1/4" E

1/4"

PORTA INSERTI CON MAGNETE EXTRA FORTE

attacco: DIN 3126, E 6,35

| | | | |
|---------------------------|---------------|---------|-------|
| FERMEC articolo | Ø testa mm | L mm | |
| 80943 | 1/4" | 20 X 30 | 130 1 |

NEW **JAPAN**



ESAGONO 1/4" E

PORTA INSERTI CON MAGNETE EXTRA FORTE CON IMPUGNATURA, CON INSERTI E PORTA INSERTO COMPRENDE:

- PORTA INSERTI CON IMPUGNATURA
- PORTA INSERTI
- INSERTI ATT. 1/4" LUNG. 25 MM:
 - PH 1 - 2 - 3
 - TAGLIO 4 - 7 MM
 - ESAGONO 2 - 3 - 4 - 5 MM
 - ADATTATORE PORTA BUSSOLE ATTACCO QUADRO 1/4"

attacco: DIN 3126, E 6,35

| | | | |
|---------------------------|---------------|---------|---|
| FERMEC articolo | Ø testa mm | L mm | |
| FM 34908 | 20 X 30 | 223 | 1 |

ESAGONO 1/4" E



53MM 77MM 19MM

ARTICOLO IN ESAURIMENTO

PORTA INSERTI AD ANGOLO 90° - CON MINIME DIMENSIONI DI INGOMBRO - MOVIMENTO SU MICRO-CUSCINETTI

DA UTILIZZARE SOLO CON BASSI LIVELLI DI COPPIA

!!!ARTICOLO NON SOGGETTO A GARANZIA!!!

attacco: DIN 3126, E 6,35

| | | | |
|---------------------------|---------|-----------|-------|
| FERMEC articolo | Ø mm | L mm | |
| 85685 | 1/4" | 19 X 28,5 | 130 1 |



35 25 1/4"

ESAGONO 1/4" E

PORTA INSERTI AD ANGOLO DI 90° PROFESSIONALE

COPPIA MASSIMA 75 NM

MADE IN JAPAN

attacco: DIN 3126, E 6,35

| | | | |
|---------------------------|---------------|---------|-------|
| FERMEC articolo | Ø testa mm | L mm | |
| 83675 | 1/4" | 35 X 25 | 130 1 |



35 26 1/4"

ESAGONO 1/4" E

PORTA INSERTI AD ANGOLO DI 90°

- MAX 2000 GIRI AL MINUTO (RPM)
- COPPIA MASSIMA 57 NM
- IMPUGNATURA REGOLABILE

attacco: DIN 3126, E 6,35

| | | | |
|---------------------------|---------------|---------|-------|
| FERMEC articolo | Ø testa mm | L mm | |
| 87397 | 1/4" | 35 X 26 | 140 1 |

PORTA INSERTI AD ANGOLO



| | |
|------------------------|--|
| BGS articolo | DESCRIZIONE |
| BGS 9758 | PORTA INSERTI AD ANGOLO 90° CON 3 INSERTI |

CARATTERISTICHE

- attacco 1/4"
- 3 inserti: PH 1, PH2, PZ1
- lunghezza: 155 mm
- altezza testa: 31 mm
- peso 280 g

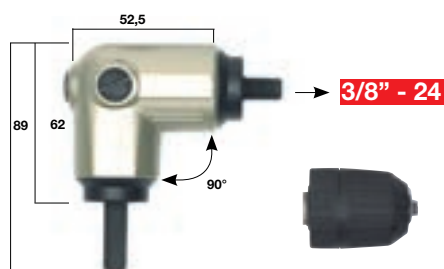

RINVIO ANGOLARE SENZA MANDRINO, 90° PORTA MANDRINO PER FORARE
ATTENZIONE: DA NON USARE CON TRAPANI A PERCUSSIONE

attacco: Esagonale 9 mm per trapano

| articolo | Filetto | Descrizione | |
|--------------|-----------|-----------------------------|---|
| 89832 | 3/8" - 24 | RINVIO ANGOLARE | 1 |
| 89206 | 3/8" - 24 | MANDRINO AUTOBLOCCANTE 1/10 | 1 |

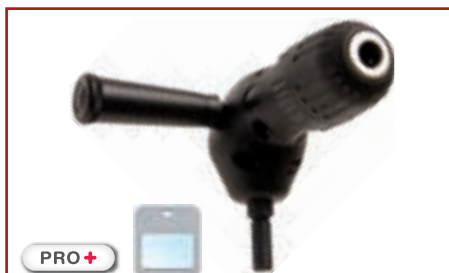

| | |
|------------------------|--|
| BGS articolo | DESCRIZIONE |
| BGS 8621 | RINVIO ANGOLARE CON MANDRINO AUTOSERRANTE |

CARATTERISTICHE

- è possibile montare l'impugnatura su entrambi i lati
- per avvitare e svitare
- con mandrino autoserrante da 10 mm (0,8 - 10 mm)
- Ø attacco: 9,5 mm
- velocità massima consentita: 500 giri/minuto
- coppia massima consentita: 30 Nm
- peso 440 g



| | |
|------------------------|--|
| BGS articolo | DESCRIZIONE |
| BGS 4847 | RINVIO ANGOLARE PER TRAPANO CON MANDRINO AUTOSERRANTE |

CARATTERISTICHE

- finitura ad alta resistenza
- ideale per lavorazioni vicino angoli
- supporto stelo con cuscinetto a sfere
- idoneo per trapanare e avvitare
- attacco stelo esagonale da 8 mm
- **con mandrino da 10 mm**
- altezza testa: 100 mm
- velocità massima consentita: 5000 giri/minuto
- coppia massima consentita: 20 Nm
- peso 500 g



PORTABUSSOLE ANGOLARE 90° CON QUADRO 3/8"

attacco: Esagonale C8 per trapano

| articolo | Ø testa mm | L mm | |
|--------------|------------|---------|-------|
| 88238 | 3/8" | 40 X 25 | 130 1 |



RINVIO ANGOLARE SENZA MANDRINO 360° REGOLABILE DISASSATO PER FORARE IN TUTTE LE POSIZIONI

ATTENZIONE: DA NON USARE CON TRAPANI A PERCUSSIONE

| articolo | Descrizione | |
|--------------|-----------------------------|---|
| 89360 | RINVIO ANGOLARE | 1 |
| 89206 | MANDRINO AUTOBLOCCANTE 1-10 | 1 |



| | |
|------------------------|--|
| BGS articolo | DESCRIZIONE |
| BGS 7992 | SET 7 PEZZI, MULTIUSO PER TRAPANO |

CARATTERISTICHE

- albero con cuscinetti a sfere
- Ø nucleo dell'albero: 6 mm
- velocità massima consentita: 5000 giri / min
- coppia massima consentita: 10 Nm
- raccordo angolare a 90° per trapano con mandrino autoserrante da 10 mm
- albero di azionamento flessibile da 1200 mm con mandrino a cremagliera da 10 mm
- prolunga con attacco esagonale da 150 mm, con mandrino a sgancio rapido
- prolunga flessibile da 150 mm
- portainseri magnetico
- fresa a sbavare
- chiave per mandrino
- in cassetta di alluminio
- peso 2,1 kg

BUSSOLE PORTA INSERTI



**BUSSOLE POWER IMPACT
CON ANELLO DI TENUTA**

attacco: Quadro femmina

| articolo | □ | ○ | L mm | 📦 |
|----------|------|-------|------|---|
| 95-0 | 1/4" | 1/4" | 26 | 1 |
| 95-1 | 1/4" | 5/16" | 26 | 1 |
| 95-2 | 3/8" | 1/4" | 31 | 1 |
| 95-3 | 3/8" | 5/16" | 30 | 1 |
| 95-4 | 1/2" | 1/4" | 38 | 1 |
| 95-4-M | 1/2" | 1/4" | 38 | 1 |
| 95-5 | 1/2" | 5/16" | 38 | 1 |



**BUSSOLE POWER IMPACT
CON ANELLO DI TENUTA**

attacco: Quadro femmina

| articolo | □ | ○ | L mm | 📦 |
|----------|------|-------|------|---|
| 12139 | 1/4" | 1/4" | 25 | 1 |
| 12140 | 1/4" | 5/16" | 25 | 1 |
| 13139 | 3/8" | 1/4" | 30 | 1 |
| 13140 | 3/8" | 5/16" | 30 | 1 |
| 14139 | 1/2" | 1/4" | 35 | 1 |
| 14140 | 1/2" | 5/16" | 35 | 1 |



**BUSSOLE POWER IMPACT
CON ANELLO DI TENUTA LUNGHE**

attacco: Quadro femmina

| articolo | □ | ○ | L mm | 📦 |
|--------------------|------|-------|------|---|
| 95-0-M | 1/4" | 1/4" | 60 | 1 |
| 95-0-75 | 1/4" | 1/4" | 75 | 1 |
| 95-2-LM NEW | 3/8" | 1/4" | 65 | 1 |
| 95-2-75 | 3/8" | 1/4" | 75 | 1 |
| 95-3-75 | 3/8" | 5/16" | 75 | 1 |
| 95-4-75 | 1/2" | 1/4" | 75 | 1 |
| 95-5-75 | 1/2" | 5/16" | 75 | 1 |



**BUSSOLE PORTA INSERTI CROMATA
CON SFERA DI TENUTA**

attacco: Quadro femmina

| articolo | □ | ○ | L mm | 📦 |
|----------|------|-------|------|---|
| 2138 | 1/4" | 5/16" | 26 | 1 |
| 3137 | 3/8" | 1/4" | 30 | 1 |
| 3138 | 3/8" | 5/16" | 38 | 1 |
| 4137 | 1/2" | 1/4" | 38 | 1 |
| 4138 | 1/2" | 5/16" | 38 | 1 |



**BUSSOLE PORTA INSERTI CROMATA
CON SFERA DI TENUTA**

attacco: Quadro femmina

impronta: DIN 3126, D 6,35

| articolo | □ | ○ | L mm | 📦 |
|----------|------|-------|------|---|
| 2137 | 1/4" | 1/4" | 25 | 1 |
| BGS 8225 | 3/8" | 1/4" | 30 | 1 |
| BGS 8201 | 1/2" | 1/4" | 35 | 1 |
| BGS 8251 | 1/4" | 5/16" | 35 | 1 |
| BGS 292 | 3/8" | 5/16" | 35 | 1 |
| BGS 293 | 1/2" | 5/16" | 35 | 1 |



**BUSSOLE PORTA INSERTI CROMATA
CON SFERA DI TENUTA**

attacco: Quadro femmina

| articolo | □ | ○ | L mm | 📦 |
|----------|------|----|------|---|
| 280-0038 | 3/8" | 10 | 30 | 1 |
| 280-0012 | 1/2" | 10 | 40 | 1 |
| 281-0012 | 1/2" | 14 | 40 | 1 |



| BGS articolo | DESCRIZIONE |
|--------------|--|
| BGS 70103 | SET 5 PEZZI, ADATTATORI PORTAINSERI CON SFERA DI BLOCCAGGIO. ATT. 1/4" - 3/8" - 1/2" |

CARATTERISTICHE

- su guida metallica
- finitura cromata satinata
- comprende:
 - adattatore att. quadro femmina 1/4" - esagono femmina 1/4" (2137)
 - adattatore att. quadro femmina 3/8" - esagono femmina 5/16" (BGS 292)
 - adattatore att. quadro femmina 3/8" - esagono femmina 10 mm (280-0038)
 - adattatore att. quadro femmina 1/2" - esagono femmina 5/16" (BGS 293)
 - adattatore att. quadro femmina 1/2" - esagono femmina 10 mm (280-0012)
- peso 200 g

MANDRINI CON SGANCIO RAPIDO PER INSERTI



MANDRINO CON SGANCIO RAPIDO PER INSERTI ATTACCO 1/4" C - 5/16" C

attacco: Quadro femmina

| FERMEC articolo | 1/4" | 1/4" C | L mm | 1 |
|-----------------|------|---------|------|---|
| 10750 | | | 36 | 1 |
| 110752 | 3/8" | 1/4" C | 36 | 1 |
| 10755 | 3/8" | 5/16" C | 50 | 1 |
| 110754 | 1/2" | 1/4" C | 40 | 1 |
| 10756 | 1/2" | 5/16" C | 50 | 1 |

JAPAN



MANDRINO CON SGANCIO RAPIDO PER INSERTI 1/4" E

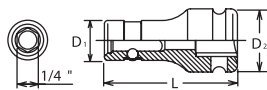

| Kokon articolo | 1/4" | D1 mm | D2 mm | L mm | 1 | Euro |
|----------------|------|-------|-------|------|---|------|
| 12142-F 6.3 | 1/4" | 16.5 | 13 | 36 | 1 | |
| 13142-F 6.3 | 3/8" | 16.5 | 19 | 45 | 1 | |
| 14142-F 6.3 | 1/2" | 16.5 | 25 | 55 | 1 | |

MANDRINI ANTIVIBRAZIONI CON PROLUNGA GUIDATA E SGANCIO RAPIDO PER INSERTI



ELIMINAZIONE DELLE VIBRAZIONI LA PROLUNGA DEL MANDRINO CALZA SULLA PARETE CILINDRICA DELL' ALBERO DELL' AVVITATORE

ATTENZIONE: CONTROLLARE LA LUNGHEZZA DELL'ALBERO!

attacco: Quadro femmina 3/8"-1/2"

| FERMEC articolo | 3/8" | 1/4" E | L mm | 1 |
|-----------------|------|--------|------|---|
| NV 3814 | 3/8" | 1/4" E | 52 | 1 |
| NV 38716 | 3/8" | 7/16" | 62 | 1 |
| NV 1214 | 1/2" | 1/4" E | 60 | 1 |
| NV 12716 | 1/2" | 7/16" | 70 | 1 |



JAPAN

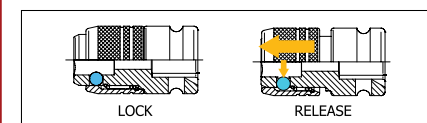

BUSSOLE PORTA INSERTI DA 7/16" (11,11 mm) CON SGANCIO RAPIDO DA 7/16"

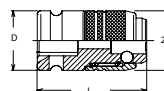

| Kokon articolo | 3/8" | D mm | L mm | 1 | Euro |
|----------------|------|------|------|---|------|
| 13142-F11.2 | 3/8" | 22 | 46 | 1 | |
| 14142-F11.2 | 1/2" | 25 | 46 | 1 | |

JAPAN



MANDRINO CON SGANCIO RAPIDO PER INSERTI ATTACCO 1/4" C

attacco: Quadro femmina

| Kokon articolo | 3/8" | 1/4" C | L mm | 1 |
|----------------|------|--------|------|---|
| 13142-D 6.3 | 3/8" | 1/4" C | 45 | 1 |
| 14142-D 6.3 | 1/2" | 1/4" C | 55 | 1 |



MANDRINO CON SGANCIO RAPIDO PER INSERTI LAME ATTACCO FORMA "E"

attacco: Quadro femmina

| FERMEC articolo | 1/4" | 1/4" E | L mm | 1 |
|-----------------|------|--------|------|---|
| 95-Q F-0 S | 1/4" | 1/4" E | 38 | 1 |
| 95-Q F-2 S | 3/8" | 1/4" E | 45 | 1 |
| 95-Q F-9 S | 3/8" | 7/16" | 51 | 1 |
| 95-Q F-4 S | 1/2" | 1/4" E | 55 | 1 |
| 95-Q F-8 S | 1/2" | 7/16" | 55 | 1 |

ADATTATORI PORTA BUSSOLE

ADATTATORI PORTA BUSSOLE

JAPAN



ADATTATORE PER BUSSOLE PER AVVITATORI AD IMPULSI - MASSA BATTENTE

| Kokon articolo | ESAGONO | | L mm | |
|----------------|---------|-------|------|---|
| 110-35 B | 1/4" | SFERA | 35 | 1 |
| 110-50 B | 1/4" | SFERA | 50 | 1 |
| 110-100 B | 1/4" | SFERA | 100 | 1 |
| 110-150 B | 1/4" | SFERA | 150 | 1 |
| 110-35 P | 1/4" | PERNO | 35 | 1 |
| 110-50 P | 1/4" | PERNO | 50 | 1 |
| 110-100 P | 1/4" | PERNO | 100 | 1 |
| 110-150 P | 1/4" | PERNO | 150 | 1 |

JAPAN



ADATTATORE PER BUSSOLE PER AVVITATORI AD IMPULSI - MASSA BATTENTE

| Kokon articolo | ESAGONO | | L mm | |
|----------------|---------|-------|------|---|
| 112-50 B | 3/8" | SFERA | 50 | 1 |
| 112-100 B | 3/8" | SFERA | 100 | 1 |
| 112-150 B | 3/8" | SFERA | 150 | 1 |
| 112-50 P | 3/8" | PERNO | 50 | 1 |
| 112-100 P | 3/8" | PERNO | 100 | 1 |
| 112-150 P | 3/8" | PERNO | 150 | 1 |

JAPAN



ADATTATORE PER BUSSOLE PER AVVITATORI AD IMPULSI - MASSA BATTENTE

| Kokon articolo | ESAGONO | | L mm | |
|----------------|---------|-------|------|---|
| 135E-60 B | 1/2" | SFERA | 60 | 1 |
| 135E-60 P | 1/2" | PERNO | 60 | 1 |



ADATTATORE PER BUSSOLE

| FEIMEC articolo | ESAGONO | | L mm | |
|-----------------|---------|-------|------|---|
| 15001.S | 1/4" | SFERA | 25 | 1 |
| 98 - 2 | 3/8" | PERNO | 32 | 1 |



ADATTATORE PER BUSSOLE

| FEIMEC articolo | ESAGONO | | L mm | |
|-----------------|---------|-------|------|---|
| 2132 - 0050 | 1/4" | SFERA | 50 | 1 |
| 98 - 1 | 1/4" | PERNO | 40 | 1 |
| BGS 2229-1 | 3/8" | SFERA | 30 | 1 |
| 98 - 3 | 3/8" | PERNO | 32 | 1 |



ADATTATORE PER BUSSOLE

| FEIMEC articolo | ESAGONO | | L mm | |
|-----------------|---------|-------|------|---|
| 13050.S | 1/4" | SFERA | 50 | 1 |
| 13050 | 1/4" | PERNO | 50 | 1 |
| 13050.75 | 1/4" | PERNO | 75 | 1 |
| 13050.100 | 1/4" | PERNO | 100 | 1 |
| 13050.100 S | 1/4" | SFERA | 100 | 1 |
| 13050.150 | 1/4" | PERNO | 150 | 1 |
| 13050.150 S | 1/4" | SFERA | 150 | 1 |
| 13050.200 | 1/4" | PERNO | 200 | 1 |
| 13050.200 S | 1/4" | SFERA | 200 | 1 |
| 13050.250 | 1/4" | PERNO | 250 | 1 |
| 13050.250 S | 1/4" | SFERA | 250 | 1 |
| 13052.S | 3/8" | SFERA | 50 | 1 |
| 13052 | 3/8" | PERNO | 50 | 1 |
| 13052.75 | 3/8" | PERNO | 75 | 1 |
| 13052.100 | 3/8" | PERNO | 100 | 1 |
| 13052.150 | 3/8" | PERNO | 150 | 1 |
| 13052.200 | 3/8" | PERNO | 200 | 1 |
| 13053.S | 1/2" | SFERA | 50 | 1 |
| 13053 | 1/2" | PERNO | 50 | 1 |
| 13053.75 | 1/2" | PERNO | 75 | 1 |
| 13053.100 | 1/2" | PERNO | 100 | 1 |

JAPAN



ADATTATORE PER BUSSOLE SNODATO

| Kokon articolo | ESAGONO | | L mm | |
|----------------|---------|-------|------|---|
| BD 024 E-3/8 | 3/8" | SFERA | 78 | 1 |
| BD 024 E-1/2 | 1/2" | SFERA | 82 | 1 |



ADATTATORE PER BUSSOLE DOPPIA FUNZIONE: CON / SENZA SNODO

| FEIMEC articolo | ESAGONO | | L mm | |
|-----------------|---------|-------|------|---|
| 48314 | 1/4" | SFERA | 100 | 1 |



| BGS articolo | DESCRIZIONE |
|--------------|---|
| BGS 9004 | 2 IN 1: PORTA INSERTI MAGNETICO E PORTA BUSSOLE |

- CARATTERISTICHE**
- funzione attacco quadro maschio 1/4"
 - funzione portainseriti esagonale femmina magnetico 1/4"
 - facendo scorrere il manicotto è possibile passare da una funzione all'altra
 - peso 60 g

SET ADATTATORI

ESAGONO 1/4" E

SFERA

1/4" 3/8" 1/2"

SET 3 PEZZI ADATTATORI 1/4 PER BUSSOLE 1/4"-3/8"-1/2" CON SFERA DI TENUTA

| articolo | ESAGONO 1/4" E | SFERA | L mm | |
|----------|----------------|----------------------|------|---|
| 13523 | 1/4" | 1/4" 3/8" 1/2" | 50 | 1 |

ESAGONO 1/4" E

SFERA

1/4" 3/8" 1/2"

CV **PRO+**

BGS 9685-1 BGS 9685-2

BGS 9685-3

| BGS articolo | DESCRIZIONE |
|--------------|-------------------------|
| BGS 9685 | SET 3 PEZZI, ADATTATORI |

- CARATTERISTICHE**
- idonei per l'uso con avvitatori
 - att. 1/4" esagonale
 - lunghezza 75 mm
 - satinati
 - 3 adattatori con attacco quadro maschio con sfera da 1/4", 3/8", 1/2"
 - peso 110 g

RICAMBI

| BGS articolo | | |
|--------------|------------|------|
| BGS 9685-1 | NEW | 1/4" |
| BGS 9685-2 | NEW | 3/8" |
| BGS 9685-3 | NEW | 1/2" |

ESAGONO 1/4" E

SFERA

1/4"-3/8"-1/2"

CV

| BGS articolo | DESCRIZIONE |
|--------------|-------------------------|
| BGS 8204 | SET 3 PEZZI, ADATTATORI |

- CARATTERISTICHE**
- satinati
 - att. 1/4" esagonale
 - 3 adattatori con attacco quadro maschio con sfera da 1/4", 3/8", 1/2"
 - lunghezza 75 mm
 - idonei per l'uso con avvitatori
 - peso 110 g

ESAGONO 1/4" E

SFERA

1/4"-3/8"-1/2"

CV **PRO+** **TESTA SFERICA**

| BGS articolo | DESCRIZIONE |
|--------------|--|
| BGS 9162 | SET 3 PEZZI, ADATTATORI, CON TESTA SFERICA |

- CARATTERISTICHE**
- comprende 3 adattatori con attacco quadro maschio con sfera di tenuta, con testa sferica da 1/4", 3/8", 1/2"
 - lunghezza:
 - quadro maschio 1/4": 65 mm
 - quadro maschio 3/8": 65 mm
 - quadro maschio 1/2": 72 mm
 - peso 100 g

SDS plus

SFERA

1/4" 3/8" 1/2"

PRO+

| BGS articolo | DESCRIZIONE |
|--------------|--|
| BGS 8214 | SET 3 PEZZI, ADATTATORI SDS-QUADRO CON SFERA |

- CARATTERISTICHE**
- 3 adattatori con attacco quadro maschio con sfera da 1/4", 3/8", 1/2"
 - consentono di utilizzare bussole su macchine con attacco SDS
 - peso 130 g

MANDRINI CON SGANCIO RAPIDO PER BUSSOLE

MANDRINO CON SGANCIO RAPIDO PER BUSSOLE "POWER IMPACT"

attacco: Quadro femmina
impronta: DIN 3126, E 11,2 - E 6,35

| FEARMEC articolo | ESAGONO | SFERA | L mm | |
|------------------|---------|-------|------|---|
| 195-SWF | 1/4" | 1/4" | 41 | 1 |
| 196-SWF | 3/8" | 3/8" | 46 | 1 |
| 97-3-125 SWF | 3/8" | 3/8" | 125 | 1 |
| 197-SWF | 1/2" | 1/2" | 60 | 1 |
| 199-SWF | 3/4" | 3/4" | 78 | 1 |
| 1991-SWF | 1" | 1" | 100 | 1 |

Kokon **JAPAN**

| articolo | ESAGONO | SFERA | L mm | |
|----------|---------|-------|------|---|
| 12222 AL | 1/4" | 1/4" | 35 | 1 |
| 13333 AL | 3/8" | 3/8" | 45 | 1 |
| 14444 AL | 1/2" | 1/2" | 55 | 1 |
| 16666 AL | 3/4" | 3/4" | 75 | 1 |
| 18888 AL | 1" | 1" | 95 | 1 |

ADATTATORI PER MANDRINI



ADATTATORE PER MANDRINI + VITE DI BLOCCAGGIO SINISTRA

| articolo | Ø Filetto | L mm |  |
|----------|-----------|------|---|
| 19005 | 3/8" - 24 | 45 | 1 |
| 19010 | 1/2" - 20 | 50 | 1 |



PER USO CON:

BGS 9937



| BGS articolo | DESCRIZIONE |
|--------------|---|
| BGS 9766 | ADATTATORE PER MANDRINI CON ATTACCO FEMMINA 1/2" UNF + VITE DI BLOCCAGGIO SINISTRA |

CARATTERISTICHE

- con attacco SDS
- 1/2" x 20 UNF
- anche per uso con mandrino BGS 9937
- peso: 50 g



ADATTATORE PER MANDRINI

| articolo | Ø Filetto | L mm |  |
|----------|-----------|------|---|
| 19250 | 1/2" - 20 | 115 | 1 |

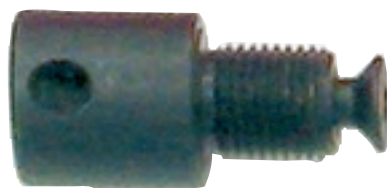

Ø Filetto

ADATTATORE CON ATTACCO QUADRO PER MANDRINI

ATTACCO FILETTATO MASCHIO

| articolo | Ø Filetto | L mm |  | |
|------------------|-----------|----------|---|---|
| 19238 | 3/8" | 1/2"-20 | 35 | 1 |
| 19212 | 1/2" | 1/2"-20 | 35 | 1 |
| 19214 NEW | 1/2" | 14 x 2.0 | 38 | 1 |



BARRA FILETTATA 3/8"-24

| articolo | Ø Filetto | L mm |  |
|----------|-----------|------|--|
| 19100 | 3/8"-24 | 28 | 1 |



ADATTATORE CON UNA FILETTATURA MASCHIO E UNA FEMMINA

| articolo | Ø Filetto | L mm |  |
|----------|------------------------|------|---|
| 19121 | 1/2" - 20 3/8" - 24 | 15 | 1 |



ADATTATORE CON DUE FILETTATURE MASCHIO

| articolo | Ø Filetto | L mm |  |
|----------|------------------------|------|---|
| 19122 | 1/2" - 20 3/8" - 24 | 26 | 1 |



VITE SINISTRA

| articolo | Ø Filetto | L mm |  |
|----------|-----------|------|---|
| VS 5 | M. 5 | 26 | 1 |
| VS 6 | M. 6 | 26 | 1 |

CHIAVI PER MANDRINI



CHIAVE PER MANDRINO A CREMAGLIERA

| articolo | PER MANDRINI |  |
|-----------|--------------|---|
| CHIAVE 4 | 4 mm | 1 |
| CHIAVE 10 | 10 mm | 1 |
| CHIAVE 13 | 13 mm | 1 |



| BGS articolo | DESCRIZIONE |
|--------------|---|
| BGS 8212 | SET 2 PEZZI, CHIAVI PER MANDRINO |

CARATTERISTICHE

- idoneo per mandrini da 10 e 13 mm
- peso 70 g



| BGS articolo | DESCRIZIONE |
|--------------|---|
| BGS 8625 | CHIAVE A CROCE UNIVERSALE PER MANDRINI A CREMAGLIERA |

CARATTERISTICHE

- idonea per la maggioranza delle misure di mandrini
- per: AEG, Bosch, Skil, B&D, Makita, Milwaukee ecc...
- misure Ø: 4 - 5,5 - 6 - 7 mm
- peso 60 g

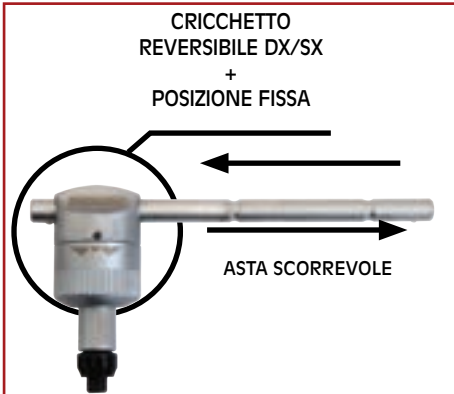

LA PRIMA CHIAVE A CRICCHETTO PER MANDRINI A CREMAGLIERA
CRICCHETTO REVERSIBILE DX/SX + POSIZIONE FISSA

MAX 68.71 NM
ASTA SCORREVOLE
DISPONIBILI:

- CHIAVE DA 10 MM A 11 DENTI
- CHIAVE DA 13 MM A 12 DENTI

| FEIMEC articolo | descrizione |
|-----------------|--|
| CRICCO 10 | CHIAVE A CRICCHETTO PER MANDRINO 10 MM |
| CRICCO 13 | CHIAVE A CRICCHETTO PER MANDRINO 13 MM |

MANDRINI



MINI MANDRINO A CREMAGLIERA DI PRECISIONE PROFESSIONALE

attacco: DIN 3126, E 6,35
serraggio: max 4 mm

| FEIMEC articolo | mm | Ø mm | L mm | box |
|-----------------|-------|------|------|-----|
| 19015 | 0,2-4 | 22 | 50 | 1 |



MANDRINO A CREMAGLIERA CON CHIAVE DI SERRAGGIO

attacco: DIN 3126, E 6,35
serraggio: max 10 mm

| FEIMEC articolo | mm | Ø mm | L mm | box |
|-----------------|----------|------|------|-----|
| 19020 | 1,5 - 10 | 33 | 50 | 1 |

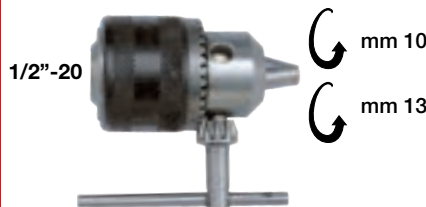

MANDRINO A CREMAGLIERA CON CHIAVE DI SERRAGGIO

attacco: 1/2" - 20
serraggio: max 10 mm - 13 mm

| FEIMEC articolo | mm | Ø mm | L mm | box |
|-----------------|----------|------|------|-----|
| 89610 | 1,5 - 10 | 33 | 50 | 1 |
| 89613 | 2 - 13 | 42 | 60 | 1 |



MANDRINO A CREMAGLIERA CON CHIAVE DI SERRAGGIO

attacco: SDS plus
serraggio: max 13 mm

| FEIMEC articolo | mm | Ø mm | L mm | box |
|-----------------|--------|------|------|-----|
| 19650 | 2 - 13 | 42 | 60 | 1 |



BGS articolo

DESCRIZIONE

BGS 9937

MANDRINO A CREMAGLIERA PER TRAPANO DA 13 MM

CARATTERISTICHE

- con adattatore SDS
- con chiave per mandrino
- peso 360 g



MANDRINO A CREMAGLIERA CON CHIAVE DI SERRAGGIO

attacco: SDS MAX
serraggio: max 13 mm

| FEIMEC articolo | mm | Ø mm | L mm | box |
|-----------------|--------|------|------|-----|
| 19850 | 2 - 13 | 42 | 170 | 1 |



MANDRINO AUTOSERRANTE CON ATTACCO QUADRO FEMMINA

attacco: QUADRO FEMMINA
serraggio: max 13 mm

| FEIMEC articolo | mm | L mm | box |
|-----------------|------|------|-----|
| 19838 | 3/8" | 80 | 1 |
| 19812 | 1/2" | 80 | 1 |





MANDRINO AUTOSERRANTE

attacco: FEMMINA
serraggio: max 10 mm - 13 mm

| FEIMEC articolo | mm | attacco | L mm | |
|-----------------|--------|-----------|------|---|
| 89206 | 1.5-10 | 3/8" x 24 | 50 | 1 |
| 89209 | 2-13 | 3/8" x 24 | 60 | 1 |
| 89207 | 1.5-10 | 1/2" x 20 | 60 | 1 |
| 89208 | 2-13 | 1/2" x 20 | 60 | 1 |



MANDRINO AUTOSERRANTE CON BLOCCAGGIO DI SICUREZZA

attacco: 1/2" - 20
serraggio: max 13 mm

| FEIMEC articolo | mm | Ø mm | L mm | |
|-----------------|----------|------|------|---|
| 89913 | 1.5 - 13 | 45 | 60 | 1 |



MANDRINO AUTOSERRANTE

| FEIMEC articolo | DESCRIZIONE |
|-----------------|--------------------------|
| BCS 9935 | 0,8-10 MM, 3/8" X 24 UNF |
| BCS 9936 | 2-13 MM, 1/2" X 20 UNF |



PER SMERIGLIATRICI



MANDRINO AUTOSERRANTE SPECIALE PER SMERIGLIATRICE CON BLOCCAGGIO DI SICUREZZA

attacco: M 14
serraggio: max 13 mm

| FEIMEC articolo | mm | Ø mm | |
|-----------------|----------|--------|---|
| 124 K | 1.5 - 13 | 1.5-13 | 1 |



MANDRINO AUTOSERRANTE

attacco: DIN 3126, E 6,35
serraggio: max 10 mm

| FEIMEC articolo | mm | Ø mm | L mm | |
|-----------------|----------|------|------|---|
| 19520 | 1.5 - 10 | 40 | 50 | 1 |



MANDRINO AUTOSERRANTE CON BLOCCAGGIO DI SICUREZZA

attacco: SDS plus
serraggio: max 13 mm

| FEIMEC articolo | mm | Ø mm | L mm | |
|-----------------|--------|------|------|---|
| 19750 | 2 - 13 | 45 | 60 | 1 |



MANDRINO AUTOSERRANTE IN ACCIAIO PER TRAPANI PORTATILI

serraggio: 0,5 - 10 mm

| FEIMEC articolo | mm | attacco | Ø | L mm | |
|-----------------|----|-----------|----|------|---|
| 89324 | 10 | 3/8" x 24 | 36 | 70 | 1 |
| 89420 | 10 | 1/2" x 20 | 36 | 70 | 1 |



MANDRINO AUTOSERRANTE IN ACCIAIO PER TRAPANI PORTATILI

serraggio: 0,5 - 13 mm

| FEIMEC articolo | mm | attacco | Ø | L mm | |
|-----------------|----|-----------|----|------|---|
| 89584 | 13 | 3/8" x 24 | 40 | 80 | 1 |
| 89512 | 13 | 1/2" x 20 | 40 | 80 | 1 |



MANDRINO AUTOSERRANTE IN ACCIAIO PER TRAPANI A PERCUSSIONE

serraggio: 0,5 - 13 mm

| FEIMEC articolo | mm | attacco | Ø | L mm | |
|-----------------|----|-----------|----|------|---|
| 89592 | 13 | 1/2" x 20 | 42 | 90 | 1 |



ADATTATORE CON ATTACCO SDS MAX PER PUNTE SDS PLUS

attacco: SDS MAX
serraggio: SDS plus

| FEIMEC articolo | SDS PLUS | L mm | |
|-----------------|----------|------|---|
| 925220 | SDS PLUS | 230 | 1 |



ADATTATORE CON ATTACCO SDS MAX PER PUNTE SDS PLUS

attacco: SDS MAX
serraggio: SDS plus

| FEIMEC articolo | SDS PLUS | L mm | |
|-----------------|----------|------|---|
| FM 410770 | SDS PLUS | 200 | 1 |



ESAGONO 13 mm.



ADATTATORE CON ATTACCO ESAGONALE 13 MM (MAKITA-HITACHI) PER PUNTE SDS PLUS

attacco: Esagono 13 mm
impronta: SDS plus

| FEIMEC articolo | SDS PLUS | MAKITA HITACHI | L mm | |
|-----------------|----------|----------------|------|---|
| 702220 | SDS PLUS | MAKITA HITACHI | 250 | 1 |

PORTAMASCHIO

ESAGONO
12 mm.
FIAM-OBBER



BUSSOLA PORTAMASCHIO CON GRANO DI BLOCCAGGIO

attacco: 12 mm FIAM-OBBER

Impronta: QUADRO "mm"

| articolo | mm | Gambo maschio mm | L mm | |
|----------|------|------------------|------|---|
| PM 20029 | 2,2 | 2,9 | 34 | 1 |
| PM 20031 | 2,5 | 3,1 | 34 | 1 |
| PM 20036 | 2,8 | 3,6 | 34 | 1 |
| PM 20041 | 3,1 | 4,1 | 34 | 1 |
| PM 20046 | 3,5 | 4,6 | 34 | 1 |
| PM 20051 | 3,9 | 5,1 | 34 | 1 |
| PM 20061 | 5,0 | 6,1 | 34 | 1 |
| PM 20063 | 5,0 | 6,3 | 34 | 1 |
| PM 20066 | 5,0 | 6,6 | 34 | 1 |
| PM 20071 | 5,6 | 7,1 | 34 | 1 |
| PM 20073 | 5,6 | 7,3 | 34 | 1 |
| PM 20081 | 6,3 | 8,1 | 34 | 1 |
| PM 20086 | 7,1 | 8,6 | 50 | 1 |
| PM 20091 | 7,1 | 9,1 | 50 | 1 |
| PM 20095 | 7,1 | 9,5 | 50 | 1 |
| PM 20101 | 8,1 | 10,1 | 50 | 1 |
| PM 20106 | 8,1 | 10,6 | 50 | 1 |
| PM 20111 | 9,1 | 11,1 | 50 | 1 |
| PM 20121 | 9,1 | 12,1 | 50 | 1 |
| PM 20126 | 10,1 | 12,6 | 50 | 1 |
| PM 20141 | 11,1 | 14,1 | 62 | 1 |
| PM 20162 | 12,3 | 16,2 | 62 | 1 |
| PM 20182 | 14,8 | 18,2 | 62 | 1 |



3/8-1/2"
Conico J1-J2
B 12

ESAGONO
12 mm.
FIAM-OBBER

MANDRINO PORTA-BUSSOLE CON ATTACCHI FIAM-OBBER

impronta: 12 mm FIAM-OBBER

| articolo | mm | mm | L mm | |
|----------|----|------------|------|---|
| 10974 | 12 | 3/8" | 60 | 1 |
| 10975 | 12 | 1/2" | 60 | 1 |
| 10976 | 12 | conico J 2 | 60 | 1 |
| 10977 | 12 | conico J 1 | 60 | 1 |
| 10978 | 12 | B12 | 60 | 1 |

PORTAMASCHIO

JAPAN

NEW



3/8" **mm.**

ESAGONO
1/4" E



CHIAVE A BUSSOLA PORTAMASCHIO CON GRANO DI BLOCCAGGIO

attacco: DIN 3126, E 6,35

Impronta: QUADRO "mm"

| articolo | mm | Gambo maschio mm | L mm | |
|----------|------|------------------|------|---|
| VA 64522 | 2,2 | 2,9 | 75 | 1 |
| VA 64525 | 2,5 | 3,1 | 75 | 1 |
| VA 64528 | 2,8 | 3,6 | 75 | 1 |
| VA 64531 | 3,1 | 4,1 | 75 | 1 |
| VA 64534 | 3,5 | 4,6 | 75 | 1 |
| VA 64581 | 3,9 | 5,1 | 75 | 1 |
| VA 64649 | 5,0 | 6,1 | 75 | 1 |
| VA 64653 | 5,0 | 6,3 | 75 | 1 |
| VA 64862 | 6,3 | 8,1 | 75 | 1 |
| VA 65108 | 8,1 | 10,1 | 75 | 1 |
| VA 64109 | 9,1 | 12,1 | 75 | 1 |
| VA 64110 | 10,1 | 12,6 | 75 | 1 |
| VA 64111 | 11,1 | 14,1 | 75 | 1 |

| Koken articolo | DESCRIZIONE | Euro |
|----------------|--|------|
| 3264 | SERIE 10 PEZZI, CHIAVI A BUSSOLA PORTAMASCHI IN CASSETTA METALLICA | |

RICAMBI

| BUSSOLE | 3131E | S 2.1 X R 2.8 S 2.7 X R 3.5 S 3.4 X R 4.5 S 4.9 X R 6 S 5.5 X R 7 S 7 X R 9 S 9 X R 11 S 9 X R 12 |
|-----------|----------|--|
| ACCESSORI | 160 K | |
| | 3260-125 | |

ESAGONO
7/16"



mm.



CHIAVE A BUSSOLA PORTAMASCHIO CON GRANO DI BLOCCAGGIO

attacco: 7/16"

Impronta: QUADRO "mm"

| FEIMEC articolo | mm | Gambo maschio mm | L mm | |
|---------------------|------|------------------|------|---|
| BU 20046 | 3,5 | 4,6 | 60 | 1 |
| BU 20061 | 5,0 | 6,1 | 60 | 1 |
| BU 20063 | 5,0 | 6,3 | 60 | 1 |
| BU 20071 | 5,6 | 7,1 | 60 | 1 |
| BU 20081 | 6,3 | 8,1 | 60 | 1 |
| BU 20091 | 7,1 | 9,1 | 60 | 1 |
| BU 20101 | 8,1 | 10,1 | 60 | 1 |
| BU 20111 | 9,1 | 11,1 | 60 | 1 |
| BU 20121 | 9,1 | 12,1 | 60 | 1 |
| BU 20122 | 11,1 | 14,1 | 60 | 1 |
| BU 20161 NEW | 12,1 | 16,2 | 60 | 1 |
| BU 20162 | 12,3 | 16,2 | 60 | 1 |
| BU 20182 NEW | 14,8 | 18,2 | 60 | 1 |

1/2"

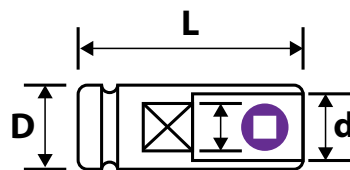

BUSSOLA PORTAMASCHIO CON GRANO DI BLOCCAGGIO
ATTACCO QUADRO 1/2" CON FORO PER SPINA E ANELLO

| FEIMEC articolo | mm | d mm | D mm | L mm | |
|-----------------|------|------|------|------|---|
| BPM 803445 | 3,4 | 4,5 | 22 | 40 | 1 |
| BPM 804960 | 4,9 | 6,0 | 22 | 45 | 1 |
| BPM 805570 | 5,5 | 7,0 | 22 | 45 | 1 |
| BPM 806280 | 6,2 | 8,0 | 22 | 45 | 1 |
| BPM 807090 | 7,0 | 9,0 | 22 | 45 | 1 |
| BPM 808010 | 8,0 | 10,0 | 22 | 45 | 1 |
| BPM 809011 | 9,0 | 11,0 | 22 | 50 | 1 |
| BPM 809012 | 9,0 | 12,0 | 22 | 50 | 1 |
| BPM 801114 | 11,0 | 14,0 | 22 | 52 | 1 |

JAPAN

3/8"



mm.



BUSSOLA PORTAMASCHI CON ANELLO DI TENUTA

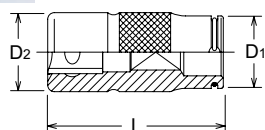

| Koken articolo | mm | Ø gambo maschio mm | D ₁ mm | L mm | | Euro |
|--------------------|-----|--------------------|-------------------|------|---|------|
| 3131 E - 2.1 X 2.8 | 2.1 | 2.8 | 6.8 | 40 | 1 | |
| 3131 E - 2.7 X 3.5 | 2.7 | 3.5 | 8 | 40 | 1 | |
| 3131 E - 3.4 X 4.5 | 3.4 | 4.5 | 9.5 | 40 | 1 | |
| 3131 E - 4.9 X 6 | 4.9 | 6 | 11.5 | 40 | 1 | |
| 3131 E - 5.5 X 7 | 5.5 | 7 | 12.5 | 40 | 1 | |
| 3131 E - 7 X 9 | 7 | 9 | 15 | 40 | 1 | |
| 3131 E - 9 X 11 | 9 | 11 | 17 | 40 | 1 | |
| 3131 E - 9 X 12 | 9 | 12 | 18 | 40 | 1 | |

NEW



1/4"

3/8"



| BGS articolo | DESCRIZIONE |
|--------------|---|
| BGS 9771 | SET 8 PEZZI, BUSSOLE PORTA-MASCHI, ATT. 1/4" E 3/8" |

CARATTERISTICHE

- attacco quadro femmina 1/4" e 3/8"
- per uso con un cricchetto o una leva con quadro scorrevole
- per maschi:
 - 1,5 mm - 12 mm
 - 1/16" - 1/2" NF / NC
- con magneti per trattenere il maschio
- ideale in spazi ristretti in cui non è possibile utilizzare un porta maschi tradizionale
- su guida metallica
- peso 320 g

JAPAN

mm.



mm.

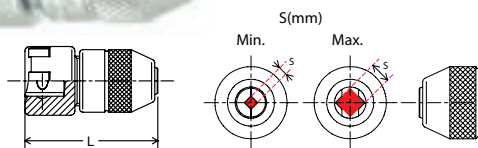

MANDRINO PORTAMASCHI REGOLABILE
ATTACCO QUADRO FEMMINA 3/8" E 1/2"

| Koken articolo | mm | S-MIN mm | S-MAX mm | L mm | | Euro |
|---------------------|------|----------|----------|------|---|------|
| 3131 A-1 | 3/8" | 2.0 | 5.0 | 42 | 1 | |
| 3131 A-2 | 3/8" | 4.5 | 8.0 | 48 | 1 | |
| 4131 A-3 NEW | 1/2" | 5.5 | 12.0 | 69 | 1 | |



MANDRINO CON IMPRONTA QUADRA, ADATTO PER MASCHI CON QUADRO DA 3,5 A 8 MM

attacco: QUADRO 1/2"
impronta: QUADRO

| FEMEC articolo | mm | L mm | |
|----------------|---------|------|---|
| ATM 12 | 3,5 / 8 | 65 | 1 |



ADATTATORI MAGNETICI PORTA MASCHI + SFERA DI BLOCCAGGIO PER CHIAVE A CRICCO POLIGONALE 13 MM

attacco: ESAGONO 13 mm

| FEMEC articolo | mm | L mm | mm | |
|----------------|---------------------------|------|----|---|
| 50601 | 4,9 | 16 | 13 | 1 |
| 50602 | 5,2 | 16 | 13 | 1 |
| 50603 | 6,2 | 16 | 13 | 1 |
| 50604 | 7,0 | 16 | 13 | 1 |
| 50605 | 9,0 | 20 | 13 | 1 |
| 50655 | SET 5 PZ. IN BOX PLASTICA | | | 1 |

AVVITA PRIGIONIERI



BUSSOLA FILETTATA AVVITA PRIGIONIERI CON ESTREMITÀ INTERNA DELLA BUSSOLA SFERICA

attacco: 12 mm FIAM-OBER
impronta: Ø FILETTO

| FEMEC articolo | Ø Filetto | L mm | |
|----------------|-----------|------|---|
| BP 120031 | M 3X0,5 | 43 | 1 |
| BP 120041 | M 4X0,7 | 43 | 1 |
| BP 120051 | M 5X0,8 | 43 | 1 |
| BP 120061 | M 6X1,0 | 43 | 1 |
| BP 120081 | M 8X1,25 | 43 | 1 |
| BP 120181 | M 8X1 | 43 | 1 |
| BP 120125 | M 10X1,25 | 43 | 1 |
| BP 120150 | M 10X1,5 | 43 | 1 |
| BP 121125 | M 12X1,25 | 43 | 1 |
| BP 120175 | M 12X1,75 | 43 | 1 |
| BP 120145 | M 14X1,50 | 43 | 1 |
| BP 120142 | M 14X2,00 | 48 | 1 |
| BP 120162 | M 16X2,00 | 48 | 1 |
| BP 120185 | M 18X2,50 | 48 | 1 |

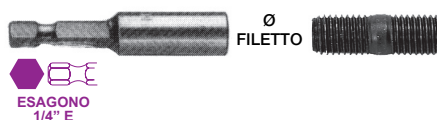

CHIAVE AVVITA PRIGIONIERI - BARRE FILETTATE ESTREMITÀ INTERNA DELLA BUSSOLA SFERICA

attacco: DIN 3126, E 6,35
impronta: Ø FILETTO

| FEMEC articolo | Ø Filetto | L mm | |
|---------------------|-----------|------|---|
| AP 3 | M 3x0,5 | 60 | 1 |
| AP 4 | M 4x0,7 | 60 | 1 |
| AP 5 | M 5x0,8 | 60 | 1 |
| AP 6 | M 6x1,0 | 60 | 1 |
| AP 8 | M 8x1,25 | 60 | 1 |
| AP 10125 NEW | M 10x1,25 | 60 | 1 |
| AP 10 | M 10x1,50 | 60 | 1 |

ANTIGRIPPAGGIO



CHIAVE AVVITA PRIGIONIERI CON SGANCIO RAPIDO ANTIGRIPPAGGIO

attacco: DIN 3126, E 6,35
impronta: Ø FILETTO

| FEMEC articolo | Ø Filetto | L mm | |
|----------------|-----------|------|---|
| AP 1/4" SP 6 | M 6x1 | 60 | 1 |
| AP 1/4" SP 8 | M 8x1,25 | 60 | 1 |

ANTIGRIPPAGGIO



CHIAVE AVVITA PRIGIONIERI CON SGANCIO RAPIDO ANTIGRIPPAGGIO

attacco: 12 mm FIAM-OBER
impronta: Ø FILETTO

| FEMEC articolo | Ø Filetto | L mm | |
|----------------|-----------|------|---|
| CP 2120061 | M 6x1 | 60 | 1 |
| CP 2120081 | M 8x1,25 | 60 | 1 |
| CP 2120150 | M 10x1,5 | 60 | 1 |
| CP 2120175 | M 12x1,75 | 60 | 1 |

AVVITA PRIGIONIERI CON ATTACCO 3/8" E 1/2" IN SEZIONE 10

UTENSILI PER CENTRAGGIO CERNIERE





UTENSILE PER CENTRARE CERNIERE PUNTA HSS 3 MM CON ATTACCO 1/4" + MOLLA E GUIDA PER CENTRARE. IDEALE PER MONTAGGIO CERNIERE

attacco: DIN 3126, E 6,35



| FEMEC articolo | Descrizione | |
|----------------|----------------|---|
| 89100 | PUNTA HSS 3 MM | 1 |

AVVITA BUSSOLE FILETTATE

ESAGONO 12 mm. FIAM-OBBER   Ø FILETTO

CHIAVE AVVITA BUSSOLE FILETTATE
attacco: 12 mm FIAM-OBBER
impronta: Ø FILETTO

| FEIMEC articolo | Ø Filetto | L mm |  |
|-----------------|--------------------|------|---|
| AB 300407 | M 4x0,7 | 45 | 1 |
| AB 300508 | M 5x0,8 | 45 | 1 |
| AB 300610 | M 6x1 | 45 | 1 |
| AB 300810 | M 8x1 | 45 | 1 |
| AB 308125 | M 8x1,25 | 45 | 1 |
| AB 300814 | M 8x14 x Mobili | 45 | 1 |
| AB 301015 | M 10x1,5 | 45 | 1 |

ESAGONO 1/4" E   Ø FILETTO

CHIAVE AVVITA BUSSOLE FILETTATE
attacco: DIN 3126, E 6,35
impronta: Ø FILETTO

| FEIMEC articolo | Ø Filetto | L mm |  |
|-----------------|--------------------|------|---|
| 11904 | M 4 | 53 | 1 |
| 11905 | M 5 | 53 | 1 |
| 11906 | M 6 | 53 | 1 |
| 11908 | M 8 | 53 | 1 |
| 11910 | M 10 | 53 | 1 |
| 11918 | M 8-14 x Mobili | 53 | 1 |
| 11920 | M 12 x 1,25 | 53 | 1 |

ANTIGRIPPAGGIO 

ESAGONO 1/4" E   Ø FILETTO

CHIAVE AVVITA BUSSOLE FILETTATE CON SGANCIO RAPIDO ANTI GRIPPAGGIO
attacco: DIN 3126, E 6,35
impronta: Ø FILETTO

| FEIMEC articolo | Ø Filetto | L mm |  |
|-----------------|-----------|------|---|
| 11904 AC | M 4 | 60 | 1 |
| 11905 AC | M 5 | 60 | 1 |
| 11906 AC | M 6 | 60 | 1 |
| 11908 AC | M 8 | 60 | 1 |
| 11910 AC | M 10 | 60 | 1 |

PORTA FILIERE



BUSSOLE PORTA FILIERE PER RIPASSARE VELOCEMENTE PRIGIONIERI, BULLONI, ECC.

attacco QUADRO

| FEIMEC articolo | misura filiera mm | L buss. mm |  |
|-----------------|-------------------|------------|---|
| BF 2050 | 1/2" d 20 x 5 h | 60 | 1 |
| BF 3011 | 1/2" d 30 x 11 h | 60 | 1 |
| BF 3810 | 1/2" d 38 x 10 h | 60 | 1 |
| BF 3814 | 1/2" d 38 x 14 h | 60 | 1 |
| BF 4514 | 3/4" d 45 x 14 h | 60 | 1 |
| BF 4518 | 3/4" d 45 x 18 h | 60 | 1 |

ESAGONO 12 mm. FIAM-OBBER  

BUSSOLE PORTA FILIERE ATT. 12 MM PER RIPASSARE VELOCEMENTE PRIGIONIERI, BULLONI, ECC.

attacco QUADRO

| FEIMEC articolo | misura filiera mm | L buss. mm |  |
|-----------------|-------------------|------------|---|
| BC 2070 | d 20 x 7 h | 72 | 1 |
| BC 2590 | d 25 x 9 h | 72 | 1 |

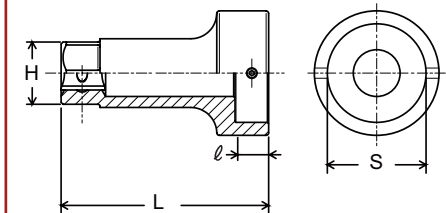

GIRAFILIERE

| Koken articolo | Ø | H mm | S mm | l mm | L mm |  | Euro |
|----------------|------|------|------|------|------|---|------|
| 3132-20 | 3/8" | 17 | 20 | 7 | 60 | 1 | |
| 4132-25 | 1/2" | 22 | 25 | 9 | 60 | 1 | |
| 4132-38 | 1/2" | 24 | 38 | 13 | 80 | 1 | |
| 4132-50 NEW | 1/2" | 27 | 50 | 16 | 105 | 1 | |

- CARATTERISTICHE**
- doppio attacco di manovra:
 - esterno esagonale
 - interno quadro femmina

PORTA FILIERE

SPECIALI

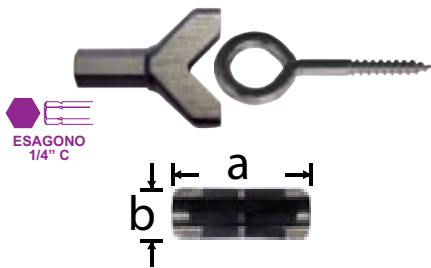

INSERTO SPECIALE PER VITI A OCCHIELLO

attacco: DIN 3126, C 6,35

| FEARMEC articolo | a x b mm | L mm | |
|------------------|------------|------|---|
| 13899 | 21,0 x 8,0 | 26 | 1 |

JAPAN

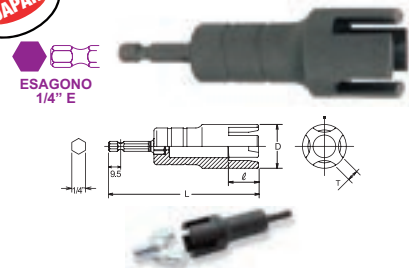

CHIAVE A BUSSOLA PER VITI E DADI CON ALETTE - GALLETTO

attacco: DIN 3126, E 6,35

| Kokon articolo | T mm | ℓ mm | L mm | |
|----------------|------|------|------|---|
| BD 017 E | 7,3 | 21 | 104 | 1 |

JAPAN



CHIAVE A BUSSOLA PER VITI E DADI CON ALETTE - GALLETTO E PER TAPPI SCARICO RADIATORI

attacco: 3/8"

| Kokon articolo | T1 mm | T2 mm | L mm | |
|----------------|-------|-------|------|---|
| 3119-3 X 5 | 3 | 5 | 30 | 1 |
| 3119-5.5 X 6 | 5.5 | 6 | 33 | 1 |

NEW

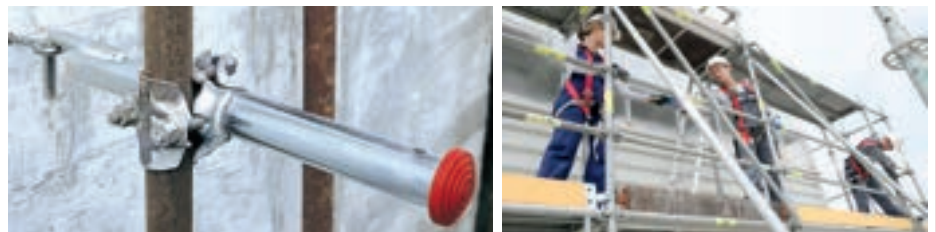
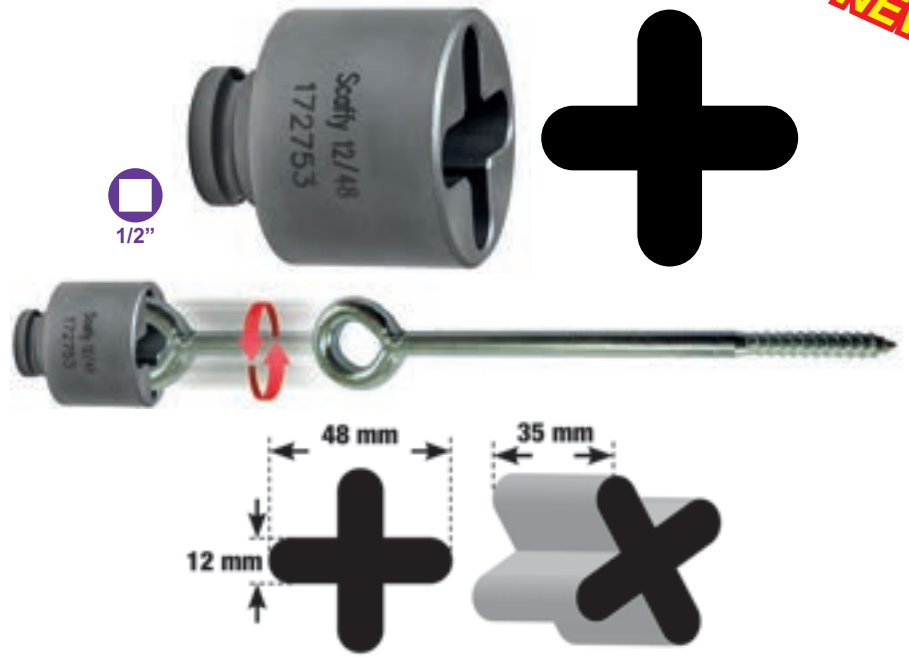

per ancoraggi meccanici per ponteggi con occhio

| FEARMEC articolo | DESCRIZIONE |
|------------------|--------------------------------|
| SCAFFY | BUSSOLA SPECIALE PER ANCORAGGI |

| CARATTERISTICHE |
|--|
| <ul style="list-style-type: none"> • attacco quadro femmina: 1/2" • speciale impronta a croce • dimensioni bussola: <ul style="list-style-type: none"> - Ø esterno: 50 mm - lunghezza: 60 mm • peso: 574 grammi |

BUSSOLE SPECIALI PER ANCORAGGI

BUSSOLE UNIVERSALI

MILLIMETRI E POLLICI



PRO+



BUSSOLA UNIVERSALE

| BGS articolo | PER MISURE | |
|---------------------|---------------|---|
| BGS 2533 | 3/8" 9-19 MM | 1 |
| BGS 2531 | 1/2" 11-30 MM | 1 |
| BGS 2833 NEW | 3/4" 12-38 MM | 1 |

CARATTERISTICHE

- adatta a tutte le impronte esagonali anche in pollici
- i perni a molla consentono un perfetto adattamento sulla maggior parte dei dadi, viti, viti a gancio, dadi ad alette e gommini

MILLIMETRI E POLLICI

NEW



BGS articolo

DESCRIZIONE

BGS 92540

SET 3 PEZZI, BUSSOLA UNIVERSALE, ADATTATORE E CHIAVE A CRICCHETTO REVERSIBILE

CARATTERISTICHE

- adatta a tutte le impronte esagonali anche in pollici
- non adatto per l'utilizzo su bulloni ruote
- comprende:
 - 1 bussola universale, attacco 3/8", 7 - 19 mm
 - 1 adattatore portabussole, attacco quadro femmina 3/8" - attacco esagonale 1/4"
 - 1 impugnatura a T a cricchetto, reversibile, attacco esagonale 1/4"
- peso 320 g

MILLIMETRI E POLLICI

NEW



PRO+



BGS articolo

DESCRIZIONE

BGS 92533

SET 3 PEZZI, BUSSOLA UNIVERSALE 9-21 MM, CON ADATTATORI

CARATTERISTICHE

- adatta a tutte le impronte esagonali anche in pollici
- non adatto per l'uso su bulloni di sicurezza per cerchi ruota
- comprende:
 - bussola universale, attacco 3/8", 9 - 21 mm (BGS 2533)
 - riduzione Femmina 1/2" - Maschio 3/8" (BGS 270)
 - adattatore per bussole, attacco esagonale 1/4", quadro maschio 3/8" (BGS 9685-2)
- peso: 280 g

MILLIMETRI E POLLICI

NEW



BGS articolo

DESCRIZIONE

BGS 70055

BUSSOLA UNIVERSALE, CON IMPUGNATURA A CRICCHETTO REVERSIBILE, 7 - 19 MM

CARATTERISTICHE

- adatta a tutte le impronte esagonali anche in pollici
- con funzione di cricchetto reversibile
- i perni a molla consentono un perfetto adattamento sulla maggior parte dei dadi, viti, viti a gancio, dadi ad alette e gommini
- per misure: da 7 a 19 mm
- peso 320 g

BUSSOLE UNIVERSALI: PER TUTTE LE IMPRONTE

